

EL-7

US Model
Canadian Model



ELCASET STEREO ELCASET DECK

SPECIFICATIONS

Power Requirements: 110 V ac, 60 Hz

Power Consumption: 46 W

Dimensions: Approx.
430 (w) x 170 (h) x 320 (d) mm
17 (w) x 6³/₄ (h) x 12⁵/₈ (d) inches
Including projecting parts and controls

Weight: Approx. 13 kg, 28 lbs 11 oz

Tape Speed: 9.5 cm/s (3³/₄ ips)

Fast Forward and Rewind Time: Approx. 60 seconds (by LC-60)

Recording system: 4-track 2-channel stereo

Bias Frequency: 160 kHz

Signal-to-noise Ratio: DOLBY NR OFF

- With Type II ELCASET (FeCr)
62 dB at peak level (NAB)
54 dB (DIN, old)
62 dB (DIN, 1975 rev.)
- With Type I ELCASET (SLH)
59 dB at peak level (NAB)
51 dB (DIN, old)
59 dB (DIN, 1975 rev.)

DOLBY NR ON
Improved by 5 dB at 1 kHz, 10 dB above 5 kHz

Total Harmonic Distortion: 0.8 %

Frequency Response: DOLBY NR OFF

- With Type II ELCASET (FeCr)
15 – 27,000 Hz (NAB)
25 – 22,000 Hz ±3 dB (NAB)
20 – 25,000 Hz (DIN)
- With Type I ELCASET (SLH)
15 – 25,000 Hz (NAB)
25 – 20,000 Hz ±3 dB (NAB)
20 – 22,000 Hz (DIN)

* 'Dolby' and the double-D symbol are the trade marks of Dolby Laboratory Inc. Noise reduction system manufactured under license from Dolby Laboratory Inc. *0 dB = 0.775 V

— Continued on page 2 —

SAFETY-RELATED COMPONENT WARNING!!

COMPONENTS IDENTIFIED BY SHADING ON THE SCHEMATIC DIAGRAMS AND IN THE PARTS LIST ARE CRITICAL TO SAFE OPERATION. REPLACE THESE COMPONENTS WITH SONY PARTS WHOSE PART NUMBERS APPEAR AS SHOWN IN THIS MANUAL OR IN SUPPLEMENTS PUBLISHED BY SONY.



Look for this mark on all products manufactured under the ELCASET standard.

SONY[®]

SERVICE MANUAL

Wow and Flutter: 0.04 % WRMS

Inputs: MIC (phone jacks) 2
sensitivity 0.3 mV (-68 dB)
for low impedance microphone
LINE IN (stereo binaural jack) . . 1
(phono jacks) 2
sensitivity 0.095 V (-18 dB)
input impedance 100 k ohms

Outputs: LINE OUT (phono jacks) 2
output level 0.775 V (0 dB)
at load impedance 100 k ohms with
LEVEL ADJUST control turned
fully clockwise
suitable load impedance more than
10 k ohms
HEADPHONES 1
suitable load impedance 8 - 32 ohms

0 dB = 0.775 V

SECTION 1
OUTLINE

1-1. BLOCK DIAGRAM - Amplifier Section -

Note: ● PB = PLAYBACK
● REC = RECORD

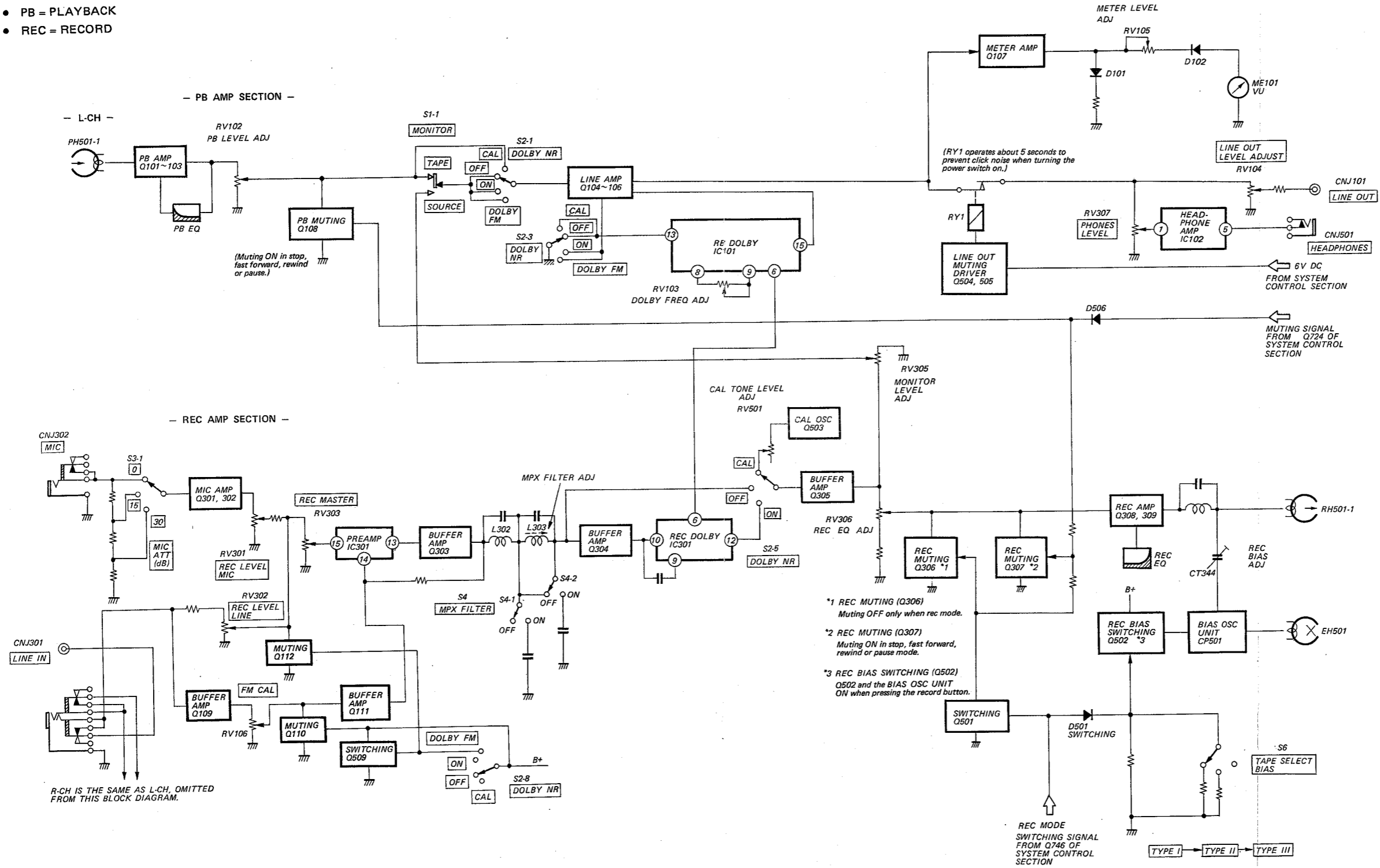

1-2. BLOCK DIAGRAM — System Control Section —

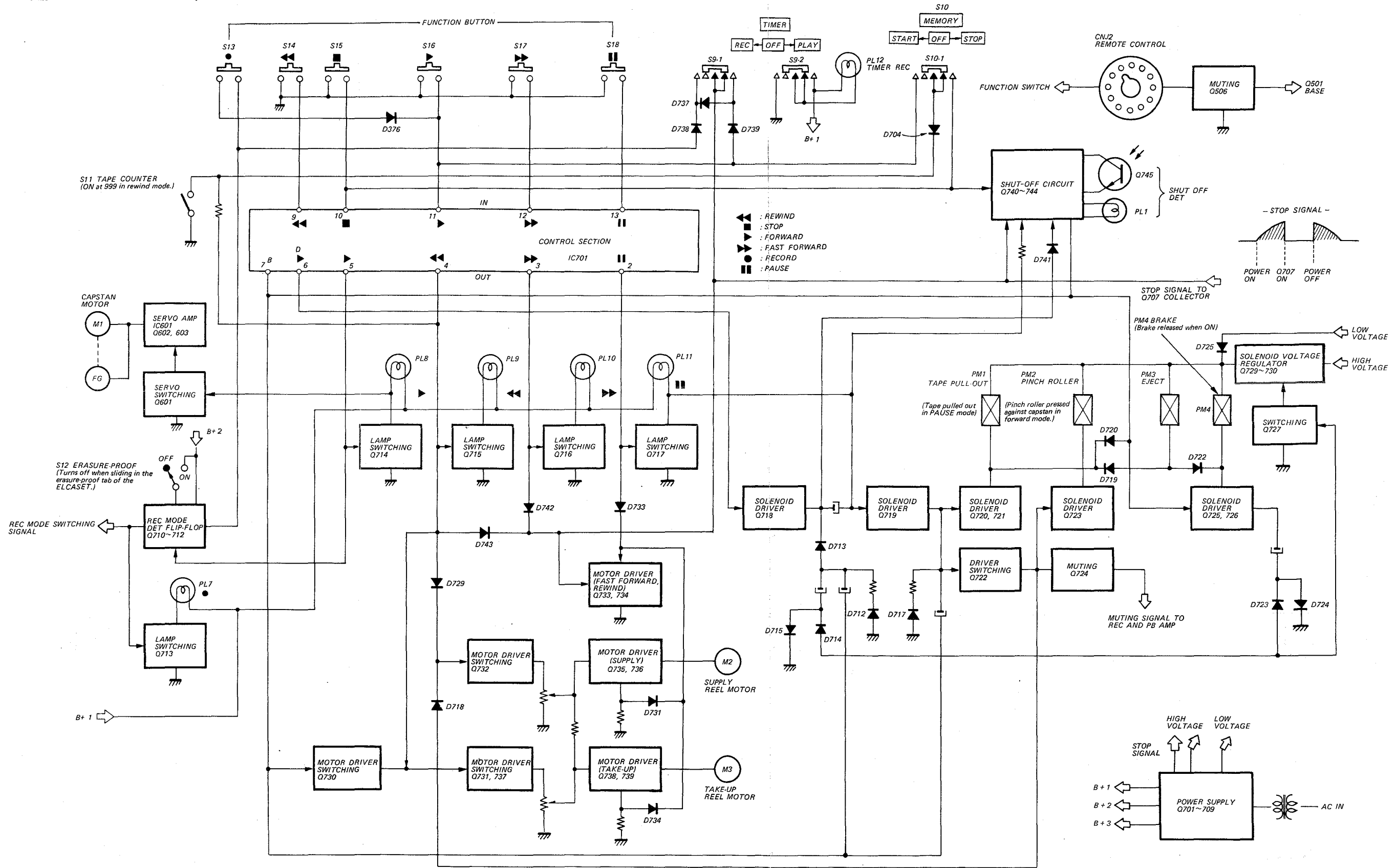

6. SCHEMATIC DIAGRAM - Amplifier Section -

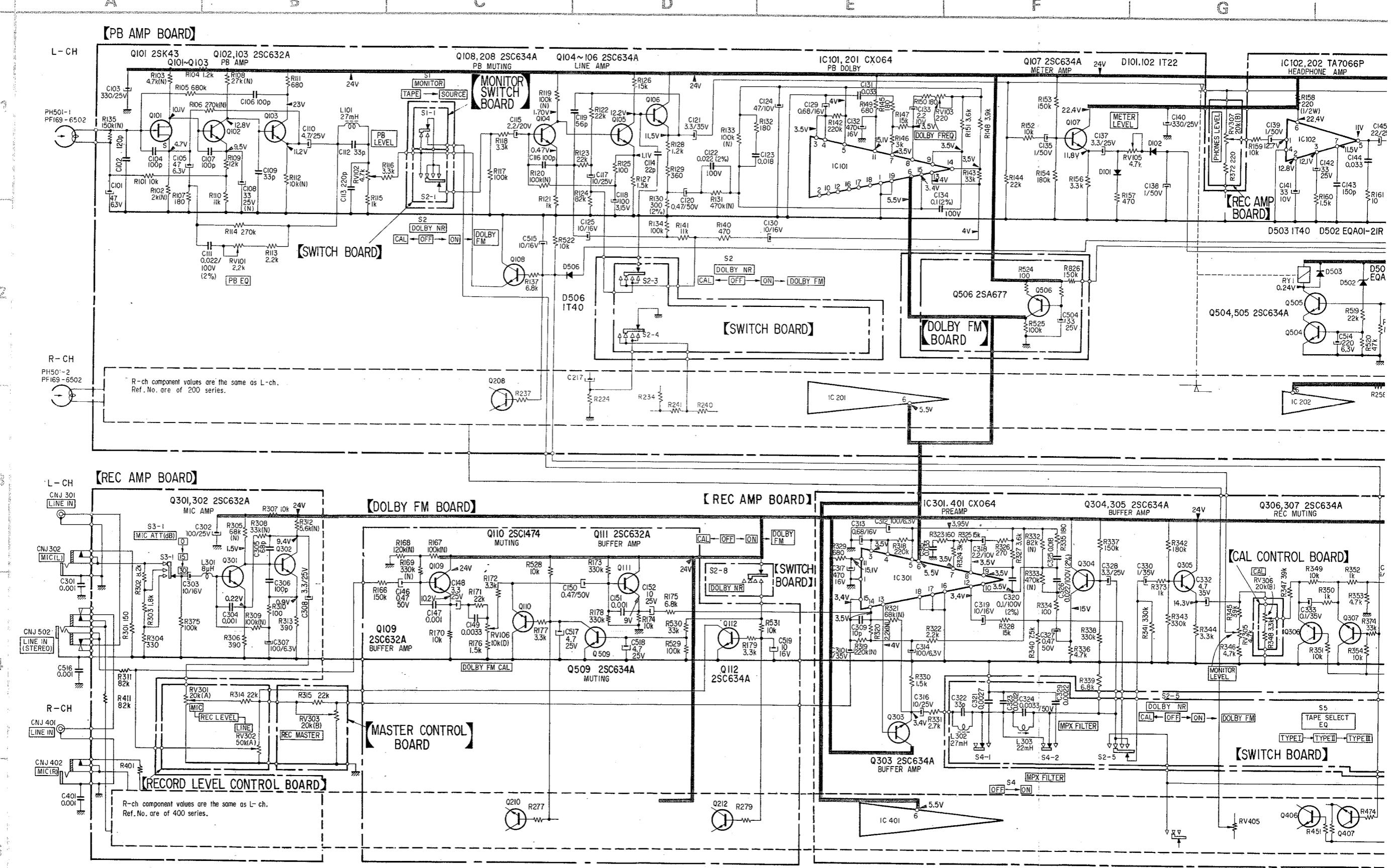

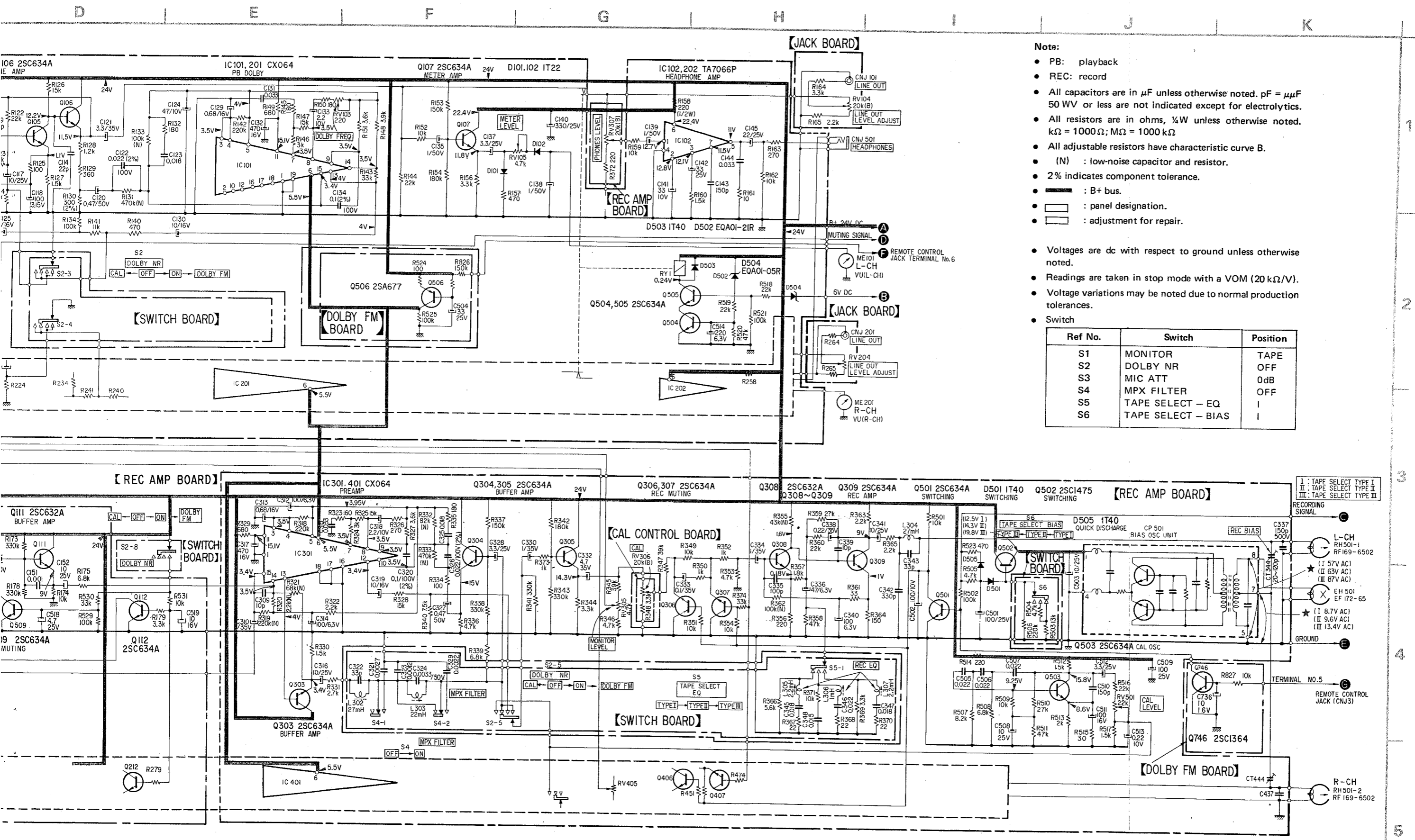

Note:

- PB: playback
- REC: record
- All capacitors are in μF unless otherwise noted. $\text{pF} = \mu\mu\text{F}$. 50 WV or less are not indicated except for electrolytics.
- All resistors are in ohms, $\frac{1}{2}\text{W}$ unless otherwise noted. $\text{k}\Omega = 1000\Omega$; $\text{M}\Omega = 1000\text{k}\Omega$
- All adjustable resistors have characteristic curve B.
- (N) : low-noise capacitor and resistor.
- 2% indicates component tolerance.
- --- : B+ bus.
- \square : panel designation.
- \square : adjustment for repair.

- Voltages are dc with respect to ground unless otherwise noted.
- Readings are taken in stop mode with a VOM (20 $\text{k}\Omega/\text{V}$).
- Voltage variations may be noted due to normal production tolerances.
- Switch

Ref No.	Switch	Position
S1	MONITOR	TAPE
S2	DOLBY NR	OFF
S3	MIC ATT	0dB
S4	MPX FILTER	OFF
S5	TAPE SELECT - EQ	I
S6	TAPE SELECT - BIAS	I

1-3. ELCASET – A New Audio Recording System –

In the audio market, the Compact Cassette of the Phillips standard has been widely accepted and has been extended even to use in hi-fi recording as a result of its easy operation and advanced technical development. On the other hand, open-reel tape is still strongly supported by music and audio enthusiasts, for its high quality sound reproduction, which has been difficult to attain with the Compact Cassette. "ELCASET" system not only realizes both the convenience of the Compact Cassette and the high sound quality of open-reel tape, but also has the following advanced features.

Wider Dynamic Range

The ELCASET tape is 6.3 mm (1/4 inch) wide and driven at a tape speed of 9.5 cm (3 3/4 ips). This results in more extended frequency and wider dynamic ranges (noticeable in higher audio range) than those of the Compact Cassette. This ample headroom does make a difference in the reproduction of many recordings.

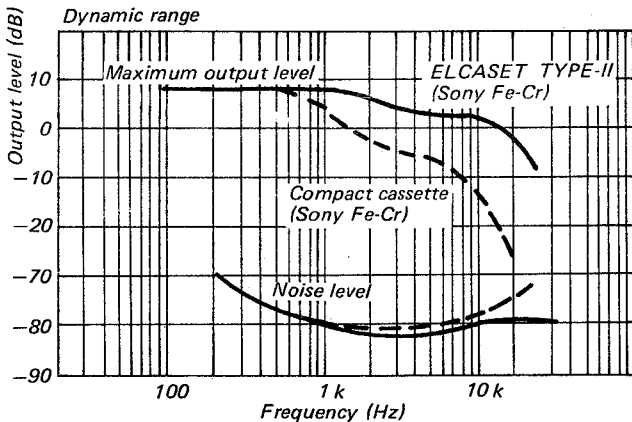

Fig. 1-1.

Stable Tape Transport (Fig. 1-3)

In conventional Compact Cassette, tape is guided by tape guide roller in a cassette itself, and accuracy of tape travel is very much dependent upon precision of cassette shells. This has been an obstacle to achieve high performance in the Compact Cassette. Another problem in the Compact Cassette is that multi-head (3-head) system has been difficult since head of recorders are put into very limited space of a cassette. In the ELCASET, tape is housed in a case but it is automatically pulled out by the transport mechanism of the recorders. Therefore, there is no influence over stableness of tape travel by precision of cassette shells and 3-head system is designed easily in recorders. As a result of these, such characteristics as wow & flutter, modulation noise, cross-talk and level changes are also remarkably improved.

Compatible Tape Track Pattern between Stereo and Monaural

The ELCASET has the same tape format as the Compact Cassette. This means tape is divided into two halves for side A and side B, each side permitting stereo or monaural recording and playback. This track pattern assignment makes possible stereo and monaural between them. The four-track tape width in the ELCASET is almost twice wider than the Compact Cassette and nearly equal to four-track open-reel tapes. This also attains excellent S/N ratio open-reel tapes are able to obtain.

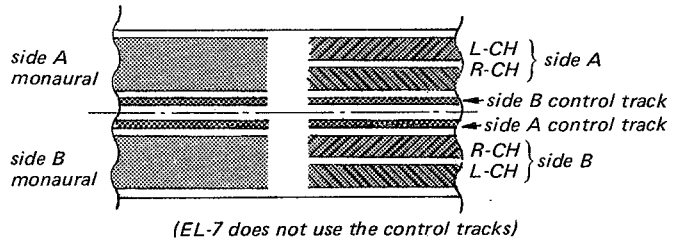

Fig. 1-2.

Tape Protectors

The ELCASET has tape protectors at left and right front ends. When the ELCASET is out of recorders, protectors are closed to protect the tape. Protectors are opened automatically by tape deck for threading tape when the ELCASET is inserted in the tape deck and a function button is depressed.

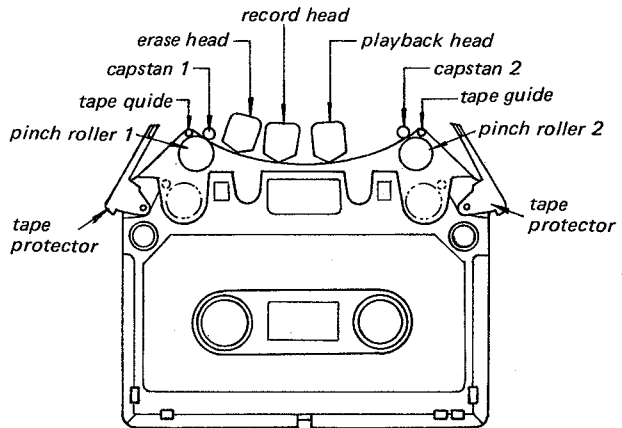

Fig. 1-3.

Reel Stoppers

Reel stoppers are also provided in the ELCASET to lock rotation of a reel hub to prevent tape from coming loose when the ELCASET is carried. The stoppers are automatically unlocked by recorders when the ELCASET is loaded on.

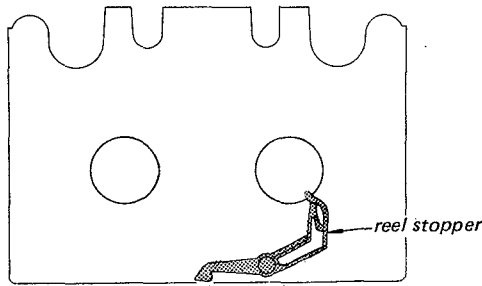

Fig. 1-4.

Erasure-proof Tabs

In the Compact Cassette, recorded tapes are protected from accidental erasure by removing a tab in a cassette. But once the tab is removed, the cassette is not used without covering the broken slot. In the ELCASET, the protection is done only by sliding tabs.

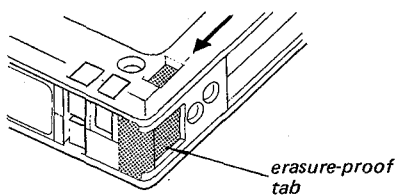

Fig. 1-5.

Types of Tape

There are three different types of tape for the ELCASET which are indicated in the labels. One is called TYPE I which has the feature of low noise output (called SLH tape by Sony). TYPE II has the same performance as FeCr tape by Sony. TYPE III will be for the tape equivalent to CrO₂ type. For optimum recording and playback results, match the tape selector on the tape recorder with the type of tape used.

Matching The Recorder Circuit with Tape Type

For optimum recording and playback results, match the tape selector on the tape deck with the type of tape used. (The types of the ELCASET are indicated in the stickers.) In a tape deck having a built-in automatic tape-type switching device, the ELCASET has holes in the tape housing that activate sensors for matching the recorder circuit (EL-7 has not this device). (The holes are factory-set.)

Noise Reduction Switching Tabs

If the tape deck has a built-in noise reduction switching device, Dolby recording and playback are automatically possible by breaking the tabs (EL-7 has not this device). To deactivate the automatic noise reduction function, cover the broken slots with cellophane or vinyl tape.

Tape	Holes
TYPE I	■ ■
TYPE II	□ ■
TYPE III	□ □

■: open □: close

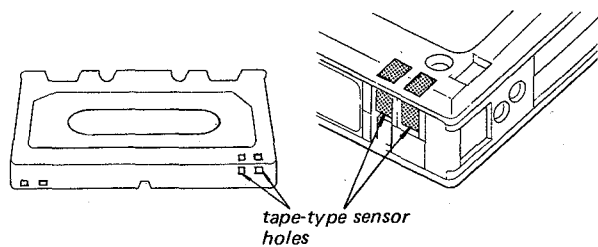

Fig. 1-6.

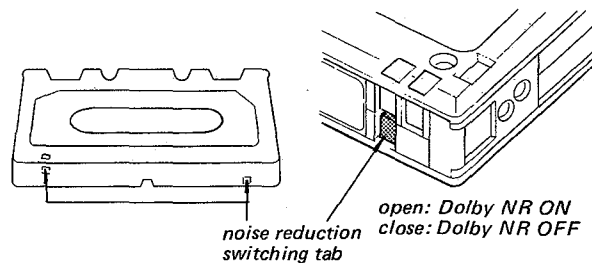
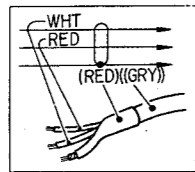

Fig. 1-7.

7. SCHEMATIC DIAGRAM — System Control Section —

Note: (for mounting diagram)

- — : indicates lead wire connection on the conductor side.
- — : indicates lead wire connection through the component side.
- : part mounted on the conductor side.
- ⊕ : B+ pattern
- Color code of sleeving over the end of the jacket.



Note:

- All capacitors are in μF unless otherwise noted. $pF = \mu\mu F$. 50 WV or less are not indicated except for electrolytics.
- All resistors are in ohms, $\frac{1}{4}W$ unless otherwise noted. $k\Omega = 1000\Omega$; $M\Omega = 1000k\Omega$
- All adjustable resistors have characteristic curve B.
- ⊞ : nonflammable resistor.
- ⊞ : fusible resistor.
- 2% indicates component tolerance.
- : B+ bus.
- : panel designation.
- : adjustment for repair.

- Voltages are dc with respect to ground unless otherwise noted.
- Readings are taken in stop mode with a VOM (20 $k\Omega/V$).
- Voltage variations may be noted due to normal production tolerances.
- Switch

Ref. No.	Switch	Position
S7	POWER	OFF
S9	TIMER	OFF
S10	MEMORY	OFF
S11	TAPE COUNTER	OFF
S12	ERASURE PROOF	OFF
S13	RECORD	OFF
S14	REWIND	OFF
S15	STOP	OFF
S16	FORWARD	OFF
S17	FAST FORWARD	OFF
S18	PAUSE	OFF
S19	CASSETTE DETECT	OFF

Note: The components identified by shading and \triangle mark are critical for safety. Replace only with part number specified.

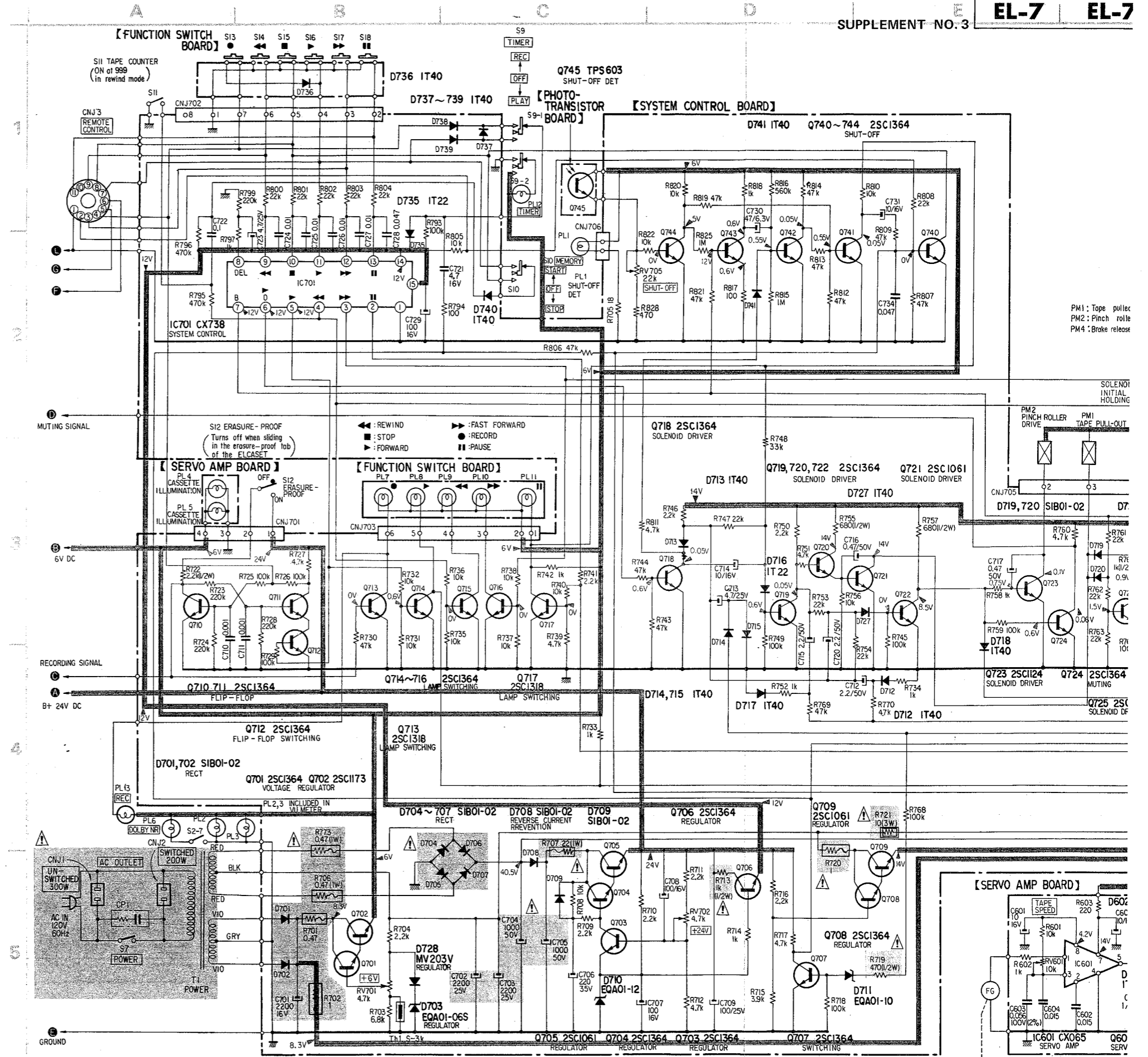

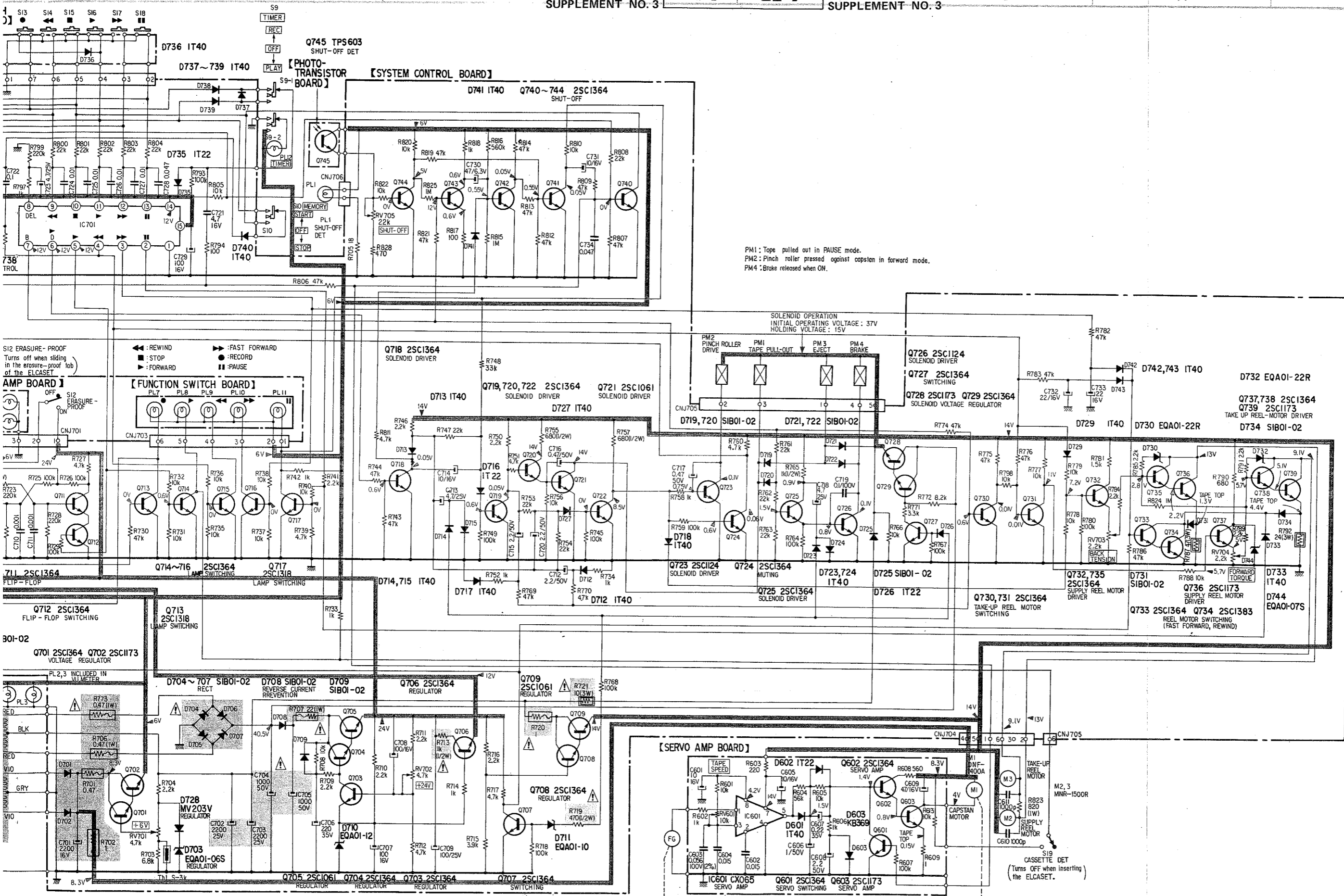

PM1: Tape pulled out in PAUSE mode.
 PM2: Pinch roller pressed against capstan in forward mode.
 PM4: Brake released when ON.

1-4. CIRCUIT DESCRIPTIONS

The EL-7 system control circuit activates the TIMER-REC, TIMER-PLAY, MEMORY-START, MEMORY-STOP and shut off operations by controlling the capstan motor drive, the voltage applied to the reel motors, and the activity of 4 solenoids following their activation by the feather-touch push-buttons.

The system control circuit is divided into separate blocks (printed on the circuit board) in order to simplify description.

(1) Power supply section (Fig. 1-8)

1. The power supply section is composed of the following stabilized power supply circuits.

- for amplifier 24 V (adjustable)
- for IC701 12 V
- for motor drive 14 V
- for lamps 6 V (adjustable)
- for solenoid drive 37 V/15 V

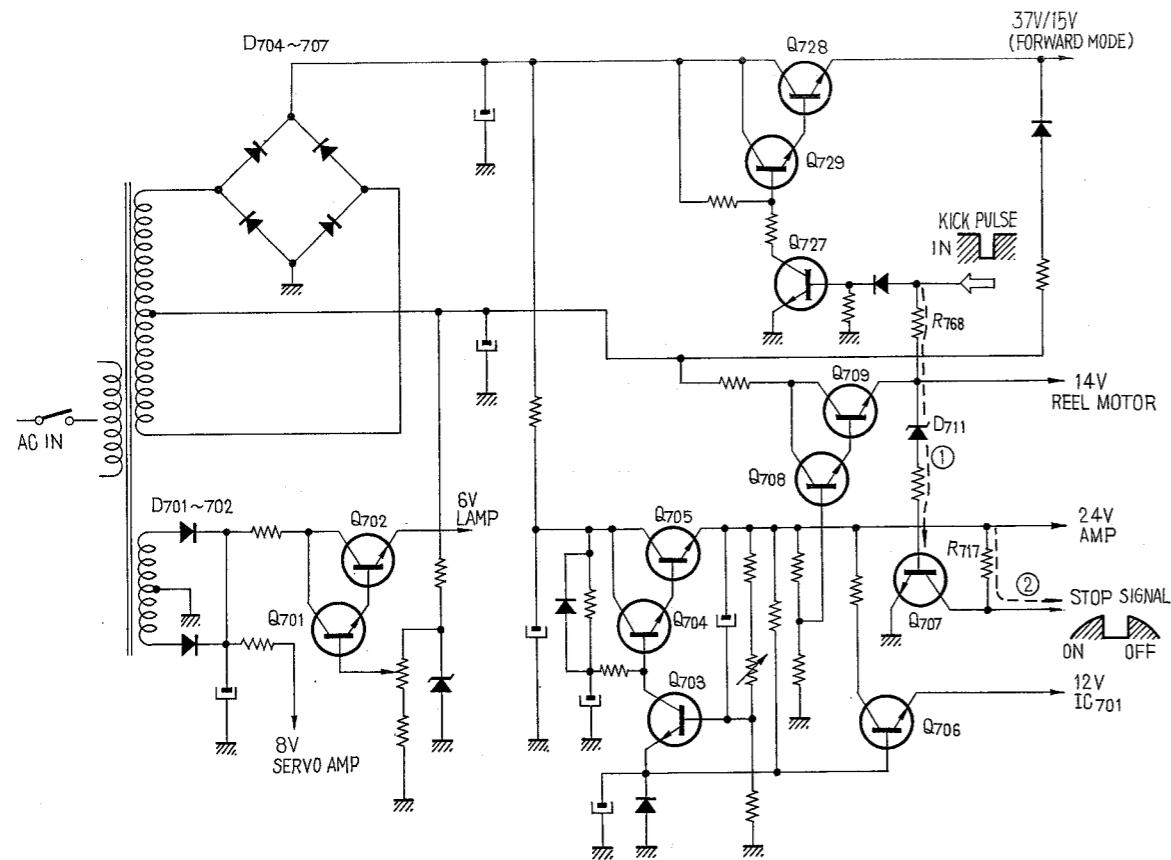

Fig. 1-8.

2. Stop signals

When the power switch turns ON or OFF, stop signals are generated by making use of the voltage changes on the Q707 collector. When the POWER switch turns ON, the start-up delay in the 24 V line is further delayed by means of the D711 Zener diode (route ①, dotted line). Consequently, during the 1.5 ~ 2.0 seconds until Q707 turns ON, stop signals flow through R717 (route ②). These signals cease once Q707 turns ON.

When the power switch turns OFF, stop signals will flow when Q707 turns OFF, making use of the fast start-up in the 14 V line. (These stop signals are described later under "Timer and Memory Operations").

3. Kick circuit (Solenoid high-voltage drive)

High voltages are applied during solenoid start-up by the switching action of Q727. (see (3) solenoid drive circuit on page 11.)

(2). IC701 (Fig. 1-9)

When any of the push buttons are pressed, the corresponding IC701 input is grounded, with the prescribed output produced at the IC output to control the relevant section. (Normally, 12 V is applied, but when the IC input drops below 4.5 V, an output is produced).

Fig. 1-9 shows the logic values of the various outputs produced in the different modes. 0 means no output, i.e., 0 V, while 1 indicates a 12 V output. HOLD during PAUSE mode means that there is no change to the previous status.

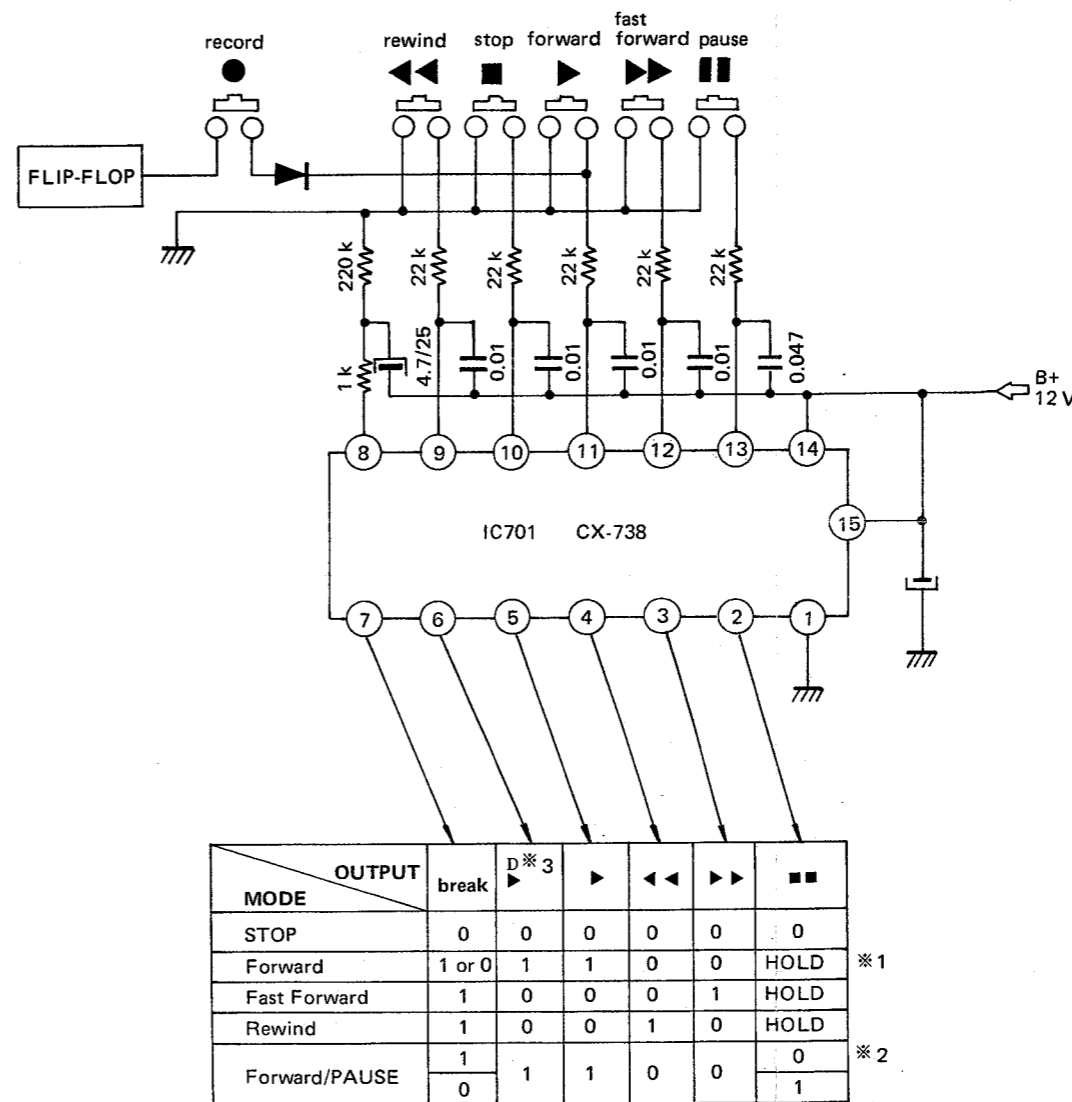

HOLD refers to previous status

※1 (If PAUSE ⇒ 0 in previous status, brake ⇒ 1)
(If PAUSE ⇒ 1 in previous status, brake ⇒ 0)

※2 (If PAUSE is switched ON during forward mode, brake solenoid is released, thus applying brake).

※3 No. 6 terminal \triangleright of IC701 is the delay forward terminal. If forward mode is selected during fast forward or rewind mode, output is produced at No. 6 later than the forward signal.

Fig. 1-9.

(3). Solenoid drive circuit (Figs. 1-10, 11, 12)

The IC output signals control 4 separate solenoids by means of transistor switches.

1. Forward button pressed when in stop mode (IC output signal: \blacktriangleright , \blacktriangleright^D , brake).

a) Due to the \blacktriangleright^D signal (route ①), Q718 turns ON, and C714 discharged. A negative pulse is applied to the base of Q719, thus Q719 turns OFF. Consequently, Q720 and 721 turn ON, activating the tape pull-out solenoid (PM1) which extracts the tape from the cassette half (routes ③ ④ ⑤). During this time, Q722 turns ON by the bias applied via R753 (route ⑥), so Q723 turns OFF, thus preventing the pinch roller solenoid (PM2) from acting. However, PM2 does operate momentarily at the same time as PM1 because of C720. After the discharge of C714 (approx. 0.22 seconds) (see Fig. 19), B+ (6V) is passed through the PAUSE lamp (PL11) and R748, and applied to the base of Q719, so Q719 turns ON (routes ⑧ ⑨). Consequently Q720 and 721 turn OFF, releasing the tape pull-out solenoid (PM1). And because Q722 turns OFF, Q723 turns ON, activating the pinch roller solenoid (PM2), and thus catching the tape in between the pinch roller and capstan (routes ⑩ ⑪).

b) The brake signal (route ⑫) turns Q725 and 726 ON, activating the brake solenoid (PM4) in order to release the brake (routes ⑬ ⑭). However, during activation of the tape pull-out solenoid (PM1) (approx. 0.22 seconds) the brake signal is grounded via D720. Therefore, Q725 and 726 turn OFF, and the brake solenoid (PM4) prevented from acting.

During activation of the tape pull-out solenoid (PM1) or the brake solenoid (PM4), the EJECT solenoid (PM3) activates to mechanically lock the EJECT button. So even if it is pressed during forward, fast forward or rewind mode, the cassette will not eject (route ⑮). The operations described above are summarized in Fig. 1-10.

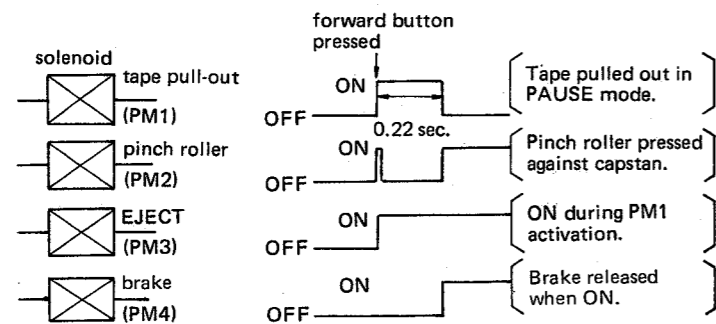

Fig. 1-10.

2. PAUSE button pressed when in forward mode. (IC output signal: \blacktriangleright , \blacktriangleright^D , PAUSE)

Since Q717 turns ON by the PAUSE signal, the bias applied via R748 ceases, and Q719 turns OFF. Therefore, Q720 and 721 turn ON, activating the tape pull-out solenoid (PM1). And since Q719 is OFF, Q722 turns ON and Q723 turns OFF, thus releasing the pinch roller solenoid (PM2).

Also as a result of the PAUSE button pressed, the forward mode brake signal ceases, releasing the brake solenoid (PM4), and applying the brake to the tape transport.

3. Fast forward or rewind button pressed when in stop or forward mode (IC output signal: brake, $\blacktriangleright\blacktriangleright$ or $\blacktriangleleft\blacktriangleleft$).

The brake solenoid (PM4) is activated by the brake signal, thus releasing the brake (routes ⑫ ⑬ ⑭).

4. PAUSE button pressed during fast forward or rewind mode (See (4) motor drive circuit on page 13.)

5. Kick circuit

During stop or forward mode, Q727 is ON by the B+ signal applied from the 14V line via R768. However, during forward mode, Q718 turns ON by the IC701 \blacktriangleright^D signal, thus discharging C713. So Q727 turns OFF by the negative pulse signal applied to its base, and the solenoid is driven by the high voltage from Q728. But if C713 is charged up again from the 14V line, Q727 will turn ON, and the solenoid activated by a low voltage. The same is true for Q725 and C718. In this way, heat generation can be avoided during normal solenoid operation.

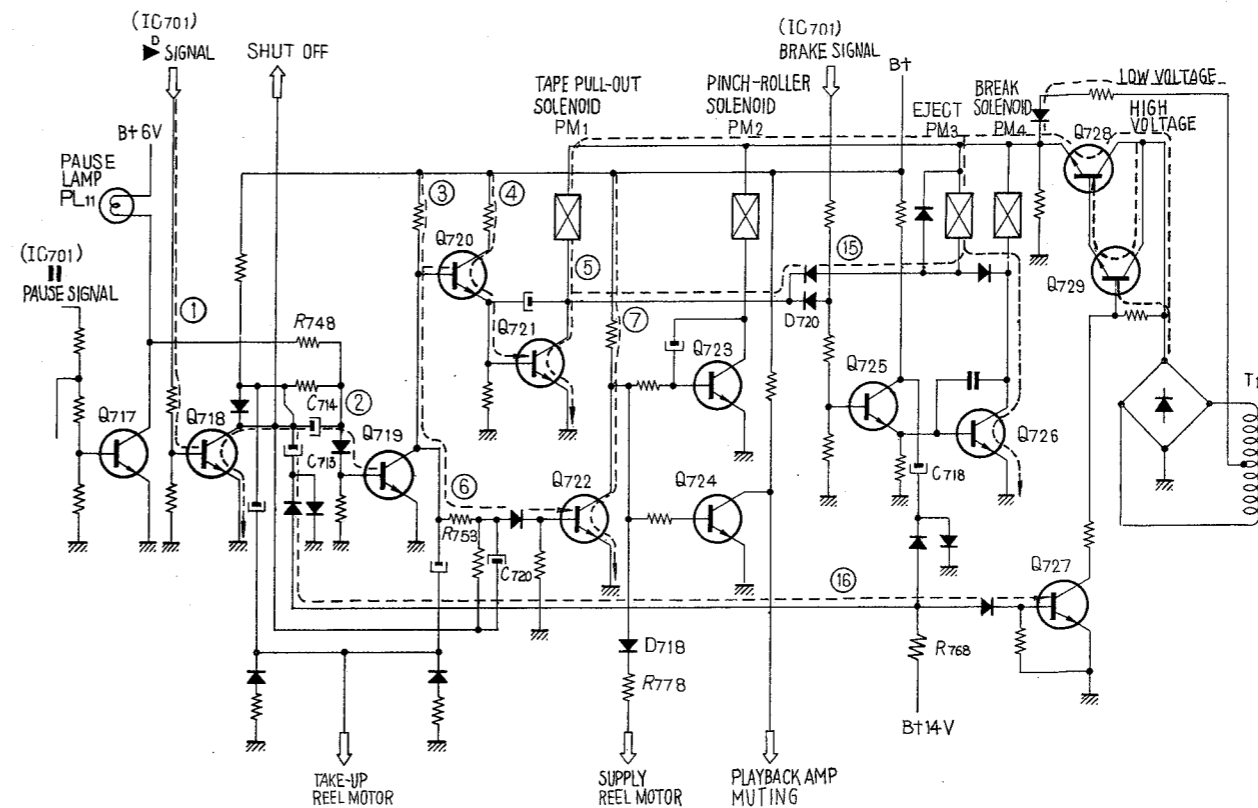

Fig. 1-11.

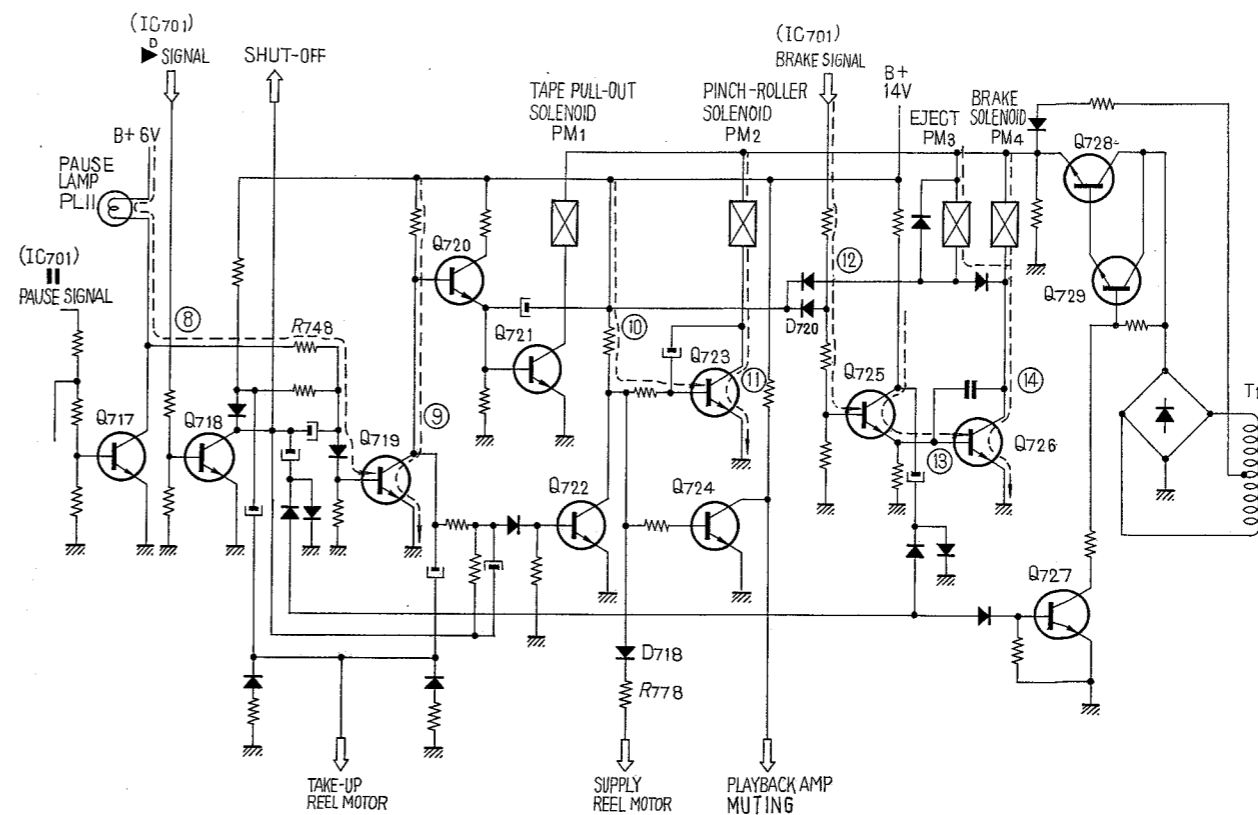

Fig. 1-12.

(4) Motor drive circuit (Fig. 1-13)

During forward, fast forward or rewind mode, the take-up and supply reel motors are controlled via transistor switches.

1. POWER switch turned ON

Q730 turns ON during the C712 charging period via R770 (route ①). Consequently, Q731 turns OFF, and Q737, 738 and 739 turn ON, thus driving the take-up reel motor, and taking up any tape slack (routes ② ③ ④ ⑤).

2. FORWARD mode

Q730 turns ON by the brake signal from IC701, thus driving the take-up reel motor (routes ② ③ ④ ⑤). In addition, since Q722 is OFF during the forward mode, a bias passing via D718 and R778 turns Q732 ON. This consequently turns Q735 and 736 ON to drive the supply reel motor (routes ⑥ ⑦ ⑧ ⑨).

3. Fast Forward mode

The take-up reel motor is started up by the brake signal from IC701. A $\blacktriangleright\blacktriangleright$ signal also from IC701 turns Q773 and 734 ON, thus short circuiting R792. So start-up is by the high voltage of the R792 voltage drop.

4. Rewind mode

Supply reel motor is started up since Q735 and 736 turn ON when the $\blacktriangleleft\blacktriangleleft$ signal from IC701 turns Q732 ON. At the same time, Q731 also turns ON, so Q737, 738 and 739 turn OFF, thus preventing the start-up of the take-up reel motor. And similar to the fast forward mode, R787 is short circuited when Q733 and 734 turn ON by the $\blacktriangleleft\blacktriangleleft$ signal, so the start-up voltage is this high-voltage drop across R787 only.

5. During fast forward or rewind mode, Q733 and 734 are ON, so a PAUSE signal from IC701 will be grounded via D733. Even if the PAUSE button is pressed in each mode, there is no brake action.

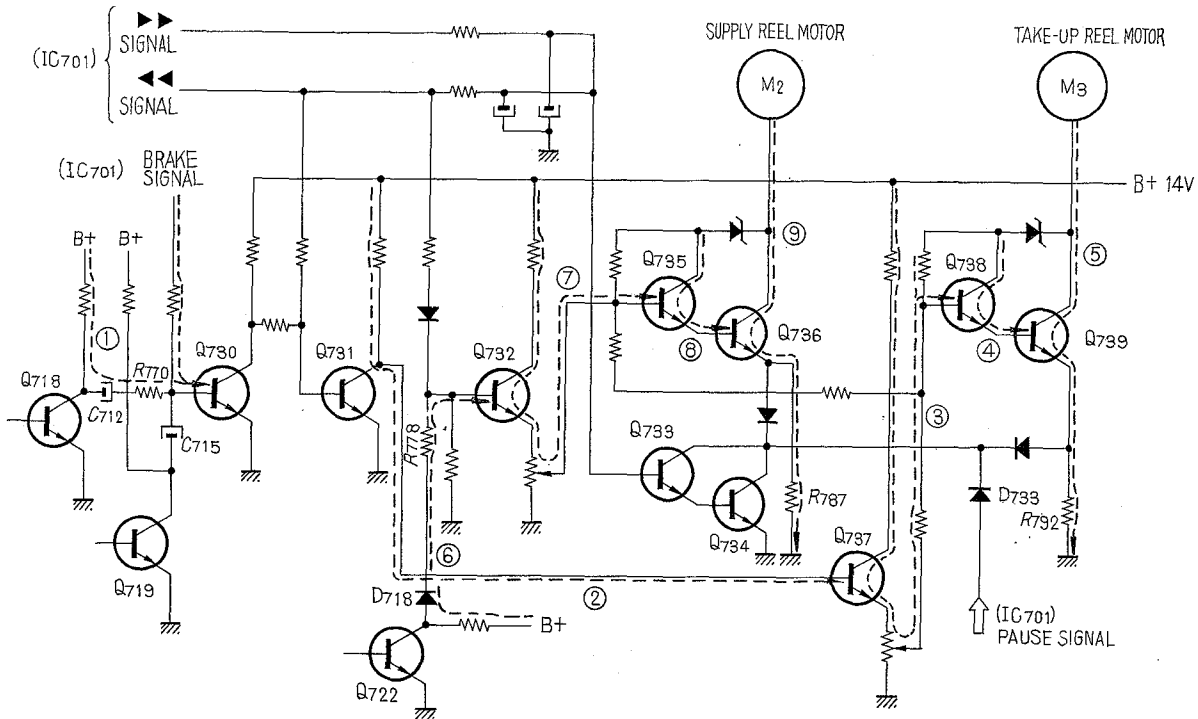

Fig. 1-13.

(5) Recording circuit (Fig. 1-4)

Record mode is detected by a flip-flop, and the record bias circuit is consequently activated.

- 1. The erasure-proof switch (S12) is turned ON when the cassette is inserted (i.e., if the erasure-proof tab have not been slide in.). When the forward and record buttons are then pressed, the Q710 base voltage is grounded, thus turning

Q710 OFF. A forward signal from IC701 turns Q712 ON, which then turns Q711 ON. But because Q710 is OFF, B+ 1 passes through R505 and D501 to turn Q502 ON. B+ 3 is applied to BIAS OSC, thus commencing the record mode. And since Q710 is OFF, Q501 turns ON, resulting in Q306, 307, 406 and 407 all turning OFF, and the record signal MUTING being released.

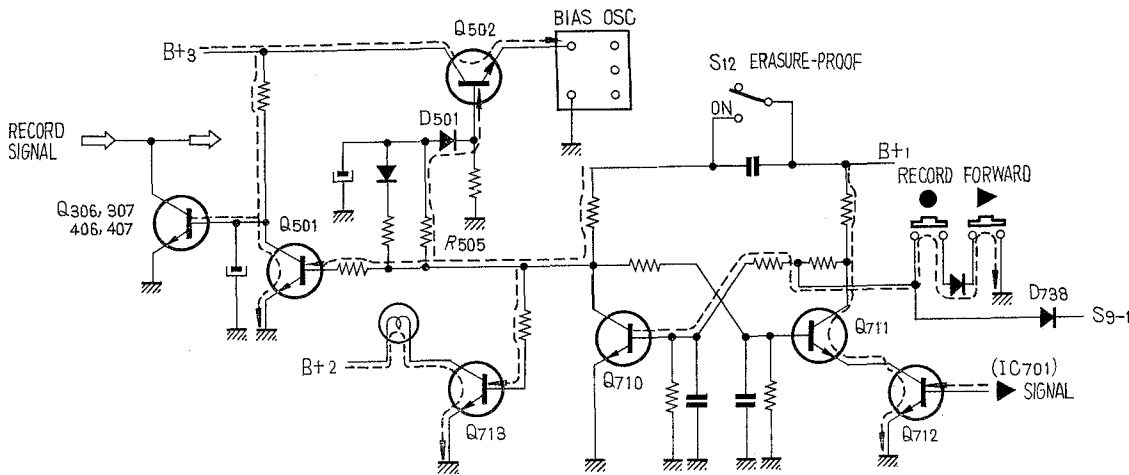

Fig. 1-14.

(6) Timer and Memory operations (Fig. 1-15)

Timer: By setting the TIMER switch (S9), alarm playback or unattended recording are possible when the power supply is turned ON.

Memory: By setting the MEMORY switch (S10), S11 will come ON when the tape counter approaches "999" in rewind mode, thus starting the mode designated by the MEMORY switch (S10) (i.e., STOP or START).

1. Alarm playback (TIMER PLAY): S9 set to PLAY

About 2.0 seconds after the power supply comes ON, Q707 turns ON. The terminal (11) of IC701 is then grounded via D739, putting the system into the forward mode (routes (1) (2)).

2. Unattended recording (TIMER REC): S9 set to REC. Q707 turns ON when the power supply

comes ON. The flip-flop is grounded via D738, and terminal (11) of IC701 is also grounded via D739 and 737. A record signal is consequently generated by the flip-flop (routes (3) (4)). (Refer to (5) recording circuit on page 14).

3. Memory STOP: S10 set to STOP

S11 turn ON when counter reaches "999" during rewind mode, and terminal (10) of IC701 is grounded via D740, thus stopping tape transport (route (4)).

4. Memory START: S10 set to START

S11 turn ON during rewind mode, and terminal (11) of IC701 is grounded via D740 to start up tape transport in forward mode (route (5)).

5. When the power switch is OFF, Q740 is ON because of STOP signal from Q707. Terminal (10) of IC701 is thus grounded, and tape transport in stop mode (routes (6) (7)).

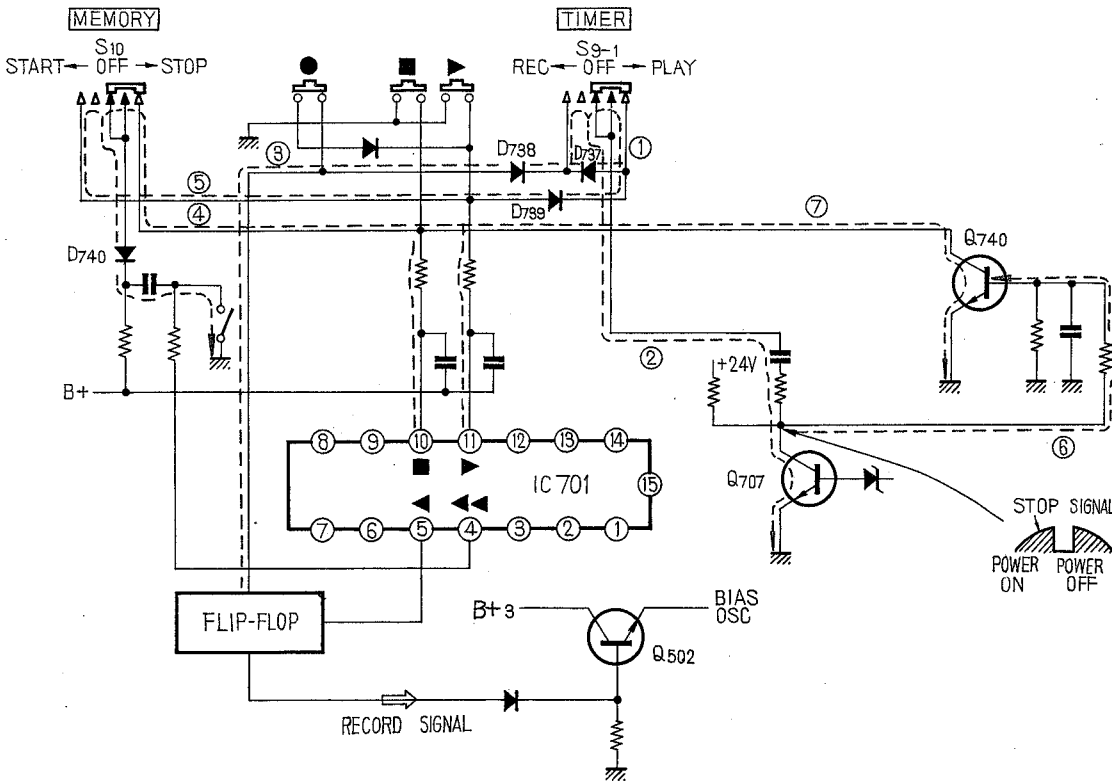

Fig. 1-15.

(7). Shut-off operation (Figs. 1-16, 17, 18)

Shut-off is activated when terminal (10) of IC701 is grounded by means of transistor switching employing the photo sensitivity of photo-transistors.

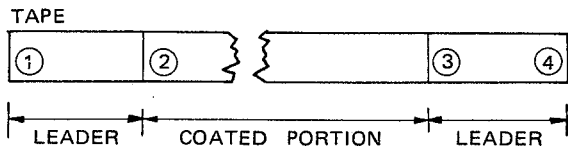

Fig. 1-16.

1. In the stop mode, and when the first tape leader portion (1) is under the tape heads, the light from lamp (PL1) is passed through the tape leader, turning Q745 (photo-transistor) ON, which then turns Q744 ON. Therefore, because there is no bias on its base, Q743 will turn OFF. But because of the bias applied via D741, Q742 will turn ON. When Q742 and Q744 are both ON at the same time, Q741 will turn OFF. Q740 will turn ON by the bias from the 6 V line via the PAUSE lamp. IC701 is thus put into the stop mode.

2. When forward button is then pressed

Q744 and 745 are both ON, and Q743 turns ON by the brake signal from IC701. Therefore, Q742 remains OFF while C730 is discharging (approx. 9 sec.). And since Q741 is ON when Q742 is OFF, point (A) is grounded, and Q740 turns OFF. So even though it is the leader tape, tape transport can be put in the forward mode. During the C730 discharge period (approx. 9 sec.), the tape moves into the coated portion. Q744 and 745 are OFF, so after the completion of the discharge, and Q742 turns ON, Q741 will turn ON because Q744 is OFF. Consequently, point (A) is grounded, Q740 turns OFF, and shut-off is prevented.

3. Arrival of leader portion at tape end (3)

The light of lamp (PL1) turns Q744 and 745 ON. And since Q742 is ON during forward mode, Q741 will turn OFF, Q740 will turn ON during the C731 discharge period (approx. 1.5 sec.), and terminal (10) of IC701 will be grounded to effect shut-off.

4. If forward button pressed (3) after shut-off

In this case, forward mode will be maintained for about 9 sec. (as the case in section 2. above). After the end of C730 discharge, Q742 comes ON, and Q741 turns OFF. Q740 turns ON because of the bias being applied to it, so shut-off status is maintained.

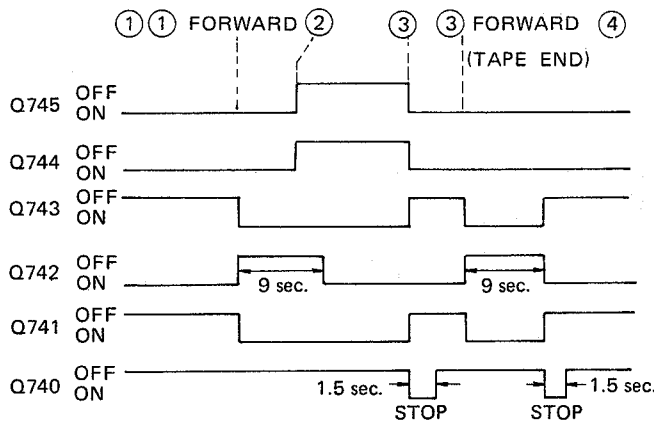

Fig. 1-17.

5. When fast forward button is pressed (②)

Although Q744 and 745 are OFF, Q743 turns ON by the brake signal from IC701. So during C730 discharge, Q742 will turn OFF, and Q741 turn ON. Therefore, Q740 turns OFF to prevent shut-off.

6. When PAUSE button pressed

Q717 turns ON by the IC701 PAUSE signal, so Q740 turns OFF to prevent shut-off.

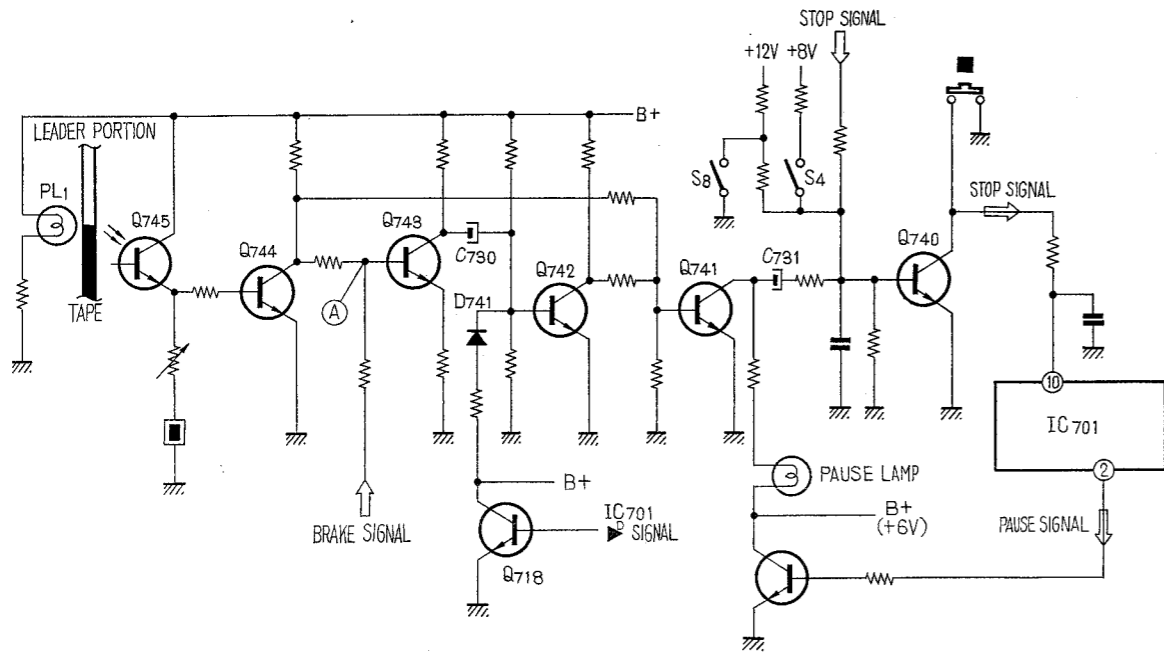

Fig. 1-18.

(8). Muting (Fig. 1-19)

1. LINE Muting

This circuit mutes click noise which produced when the POWER switch is turned ON. Q504, and Q505 do not turn ON as soon as the POWER switch (S7) turns ON, because the zener diodes D502, and D504 delay rising of the base voltages of Q504 and Q505. So until Q504 and Q505 turn ON, relay RY1 is not energized, and no output appears at LINE OUT jack (route ①, ②).

2. Record and Playback Circuit Muting

This circuit mutes output signals of the preamplifier and of the playback amplifier in the STOP, rewind, fast forward and PAUSE mode. Since Q724 is OFF in the STOP, rewind, fast forward and PAUSE mode. The base of Q108 is biased through D506 and R137 (route ③, ④). And Q108 turns ON. Similarly, the base of Q307 is biased through D506 and R374 (route ⑤, ⑥) and Q307 turns ON.

3. Record Circuit Muting by Remote Control RM-30 (optional)

This circuit mutes output signal of the preamplifier with REC MUTE switch of RM-30 turned ON. When the RM-30 REC MUTE switch turns ON in record mode, Q746 is turned ON by the base current flowing through R827 (route ⑦, ⑧). As a result, Q501 is turned OFF by decreased base voltage, thus permitting base currents to flow to Q306 through R501 and R351 (route ⑨, ⑩) and to Q307 through R501 and R354 (route ⑪, ⑫). Q306 and Q307 both turn ON, and a record signal is muted.

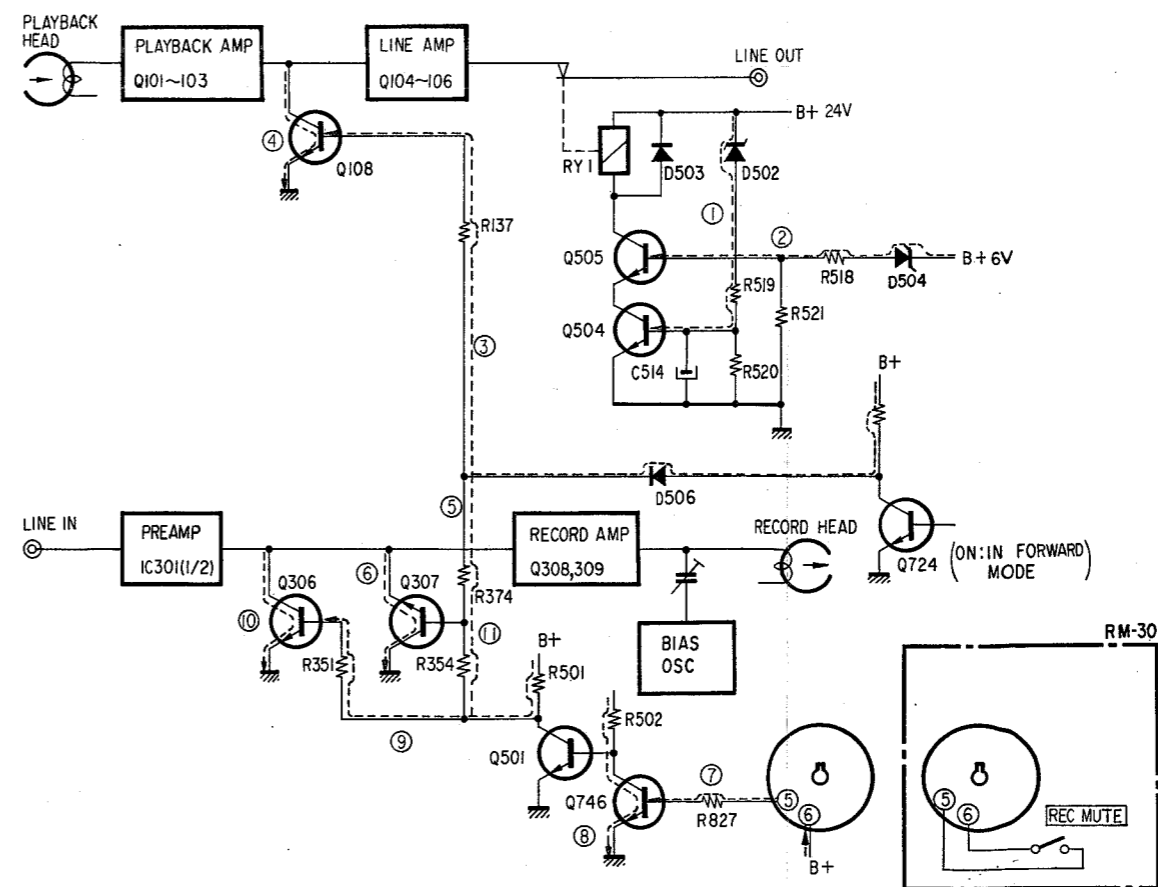
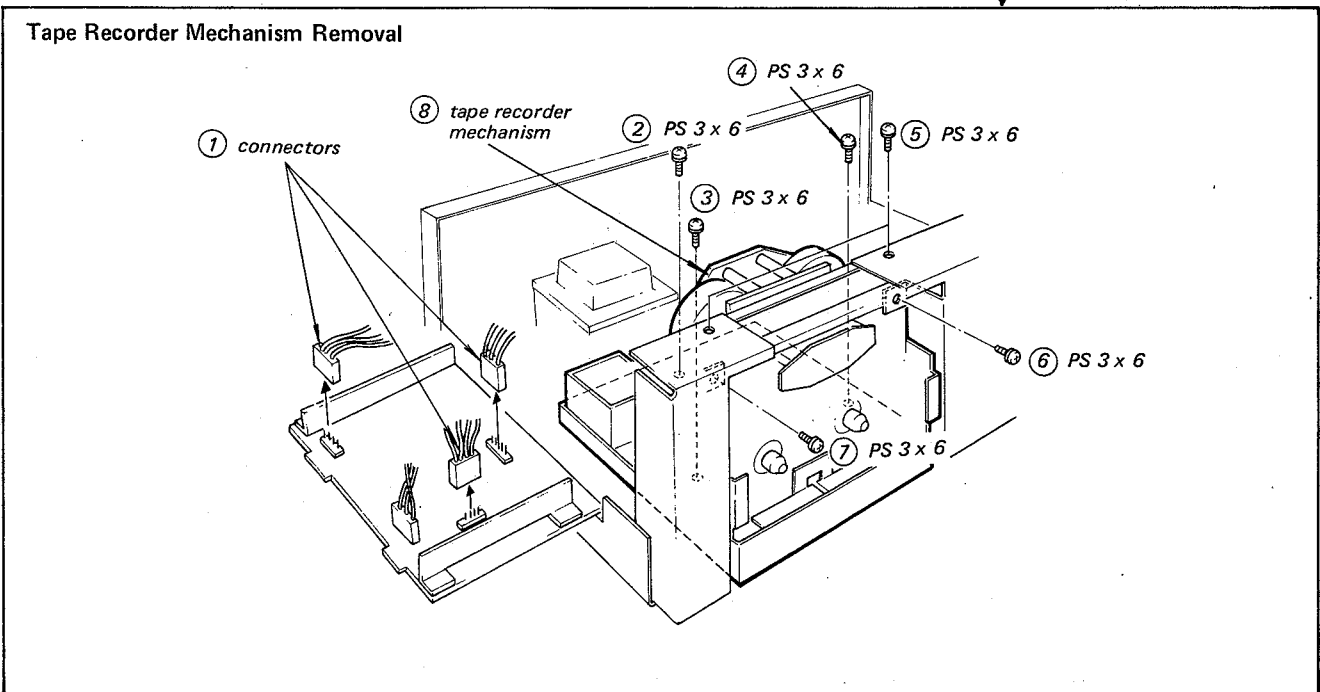
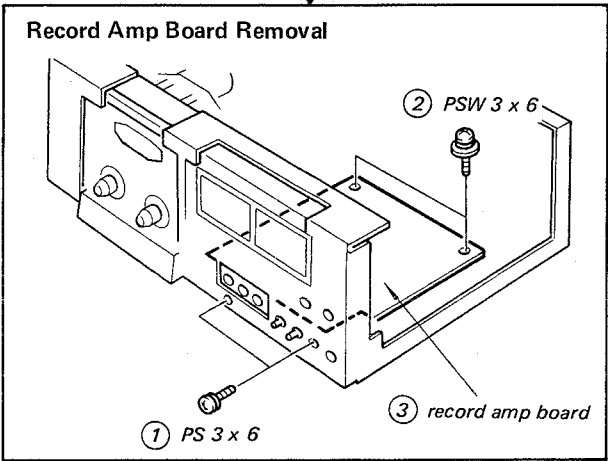
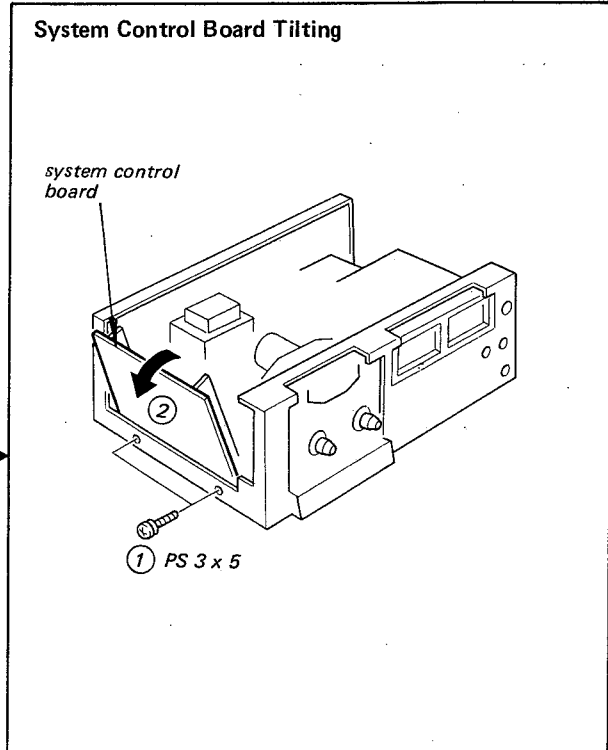
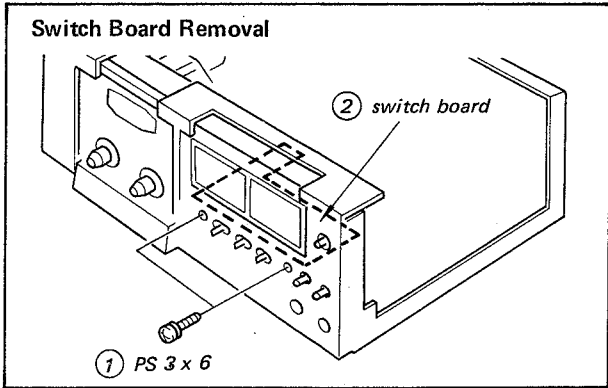

Fig. 1-19.



SECTION 3 ADJUSTMENTS

3-1. MECHANICAL ADJUSTMENTS

PRECAUTION

1. Clean the following parts with a denatured-alcohol-moistened swab:

record and playback heads	pinch roller
erase head	rubber belts
capstans	idlers
2. Demagnetize the record and playback heads with a head demagnetizer.
3. Do not use a magnetized screwdriver for the adjustments.
4. After the adjustments, apply a suitable locking compound to the parts adjusted.
5. The adjustments should be performed with the rated power supply voltage unless otherwise noted.

Test Tape L-9-MR (with a mirror: 8-918-064-15)

section	1	2	3	4
frequency	315 Hz	7 kHz	12.5 kHz	3 kHz
level	0 dB	-10 dB	-10 dB	0 dB
time	40 sec.	60 sec.	40 sec.	180 sec.

Tape Path Adjustment

Note: When adjusting or replacing the parts of head deck ass'y, turn the necessary screws only so that the head deck ass'y is adjusted with a microscope. When replacing the record and playback heads together, replace and adjust one and then the other.

Procedure:

1. Make sure that tape do not curl and twist at the tape guides using the test tape L-9-MR.

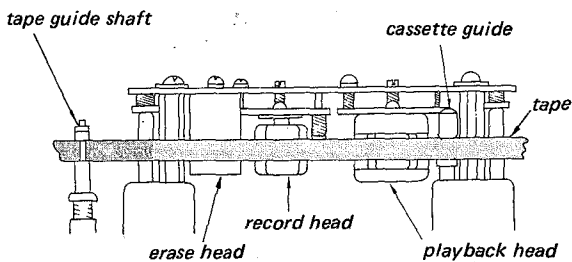

2. Adjust the head height and azimuth adjustment screws so that the upper end of tape touches the upper end of core as shown below.

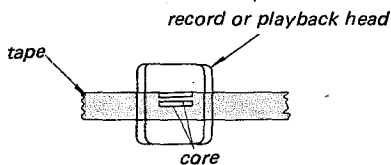

3. Mode: record and simultaneous playback

MONITOR switch: TAPE

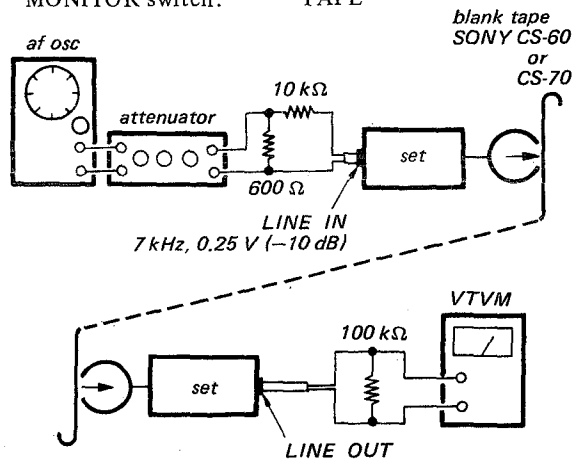

Adjust the head height and azimuth adjustment screws for a maximum reading on VTVM.

Adjustment Location:

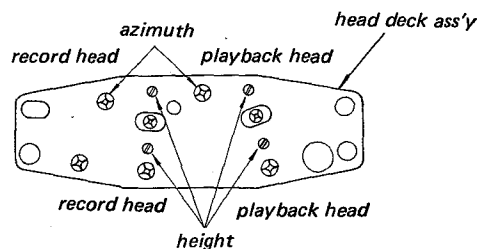

Cassette Detecting Switch (S19) Position Adjustment

When pushing the cassette holder in with a tape cassette, make sure that the lever (A) does not cross the cassette detecting switch over.

Note: If necessary, loosen the screw and adjust the switch position.

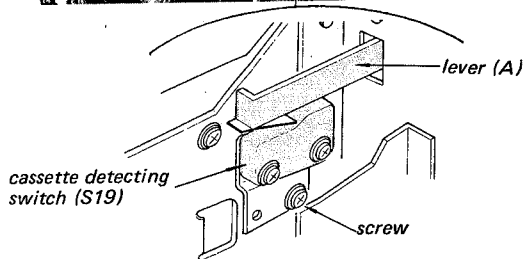
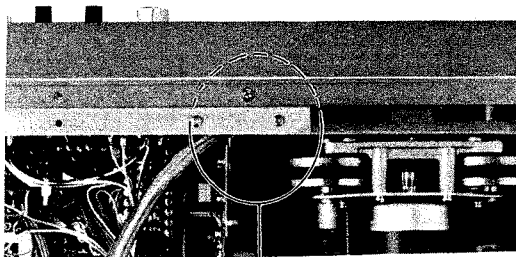

Solenoid Position Adjustment

1. Loosen the screw A and push the pinch roller solenoid in the direction shown by the arrow (A)
2. In playback and pause mode, loosen the screw B and adjust the tape pull-out solenoid position to obtain the clearance (B)

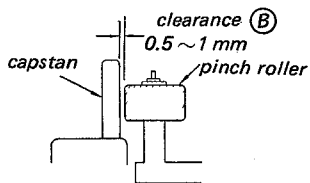
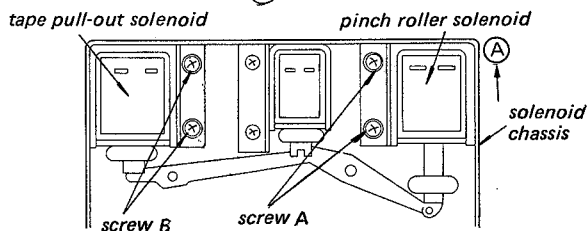

3. In playback mode, adjust the pinch roller solenoid position to obtain the clearance (C)

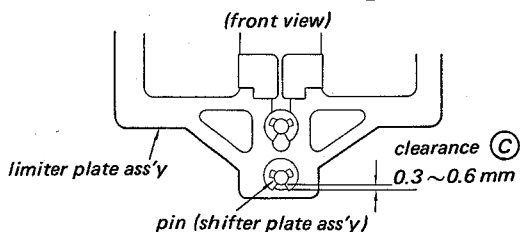

Auto Shut-off Voltage Adjustment.

1. Play back the leader tape portion of test tape.
2. Adjust RV705 to obtain the specified value.

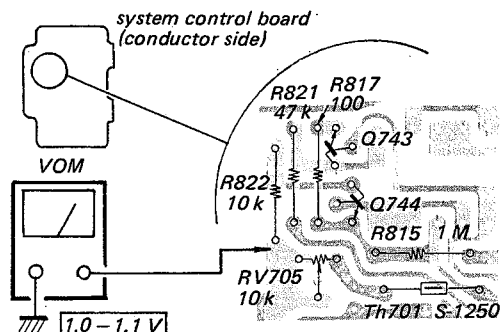

Torque Adjustment

1. Back Tension Torque – Playback mode –

Torque meter	Meter reading
CQ-101L	55-65 g cm

If necessary, adjust RV703.

2. Forward Torque – Playback mode –

Torque meter	Meter reading
CQ-101L	110-120 g cm

If necessary, adjust RV704.

3. Fast Forward Rewind Torque

Torque meter	Meter reading
CQ-201L	300-400 g cm

4. In fast forward mode, make sure that the supply reel spindle stops while lightly holding it.
5. In rewind mode, make sure that the take-up reel spindle stops while lightly holding it.

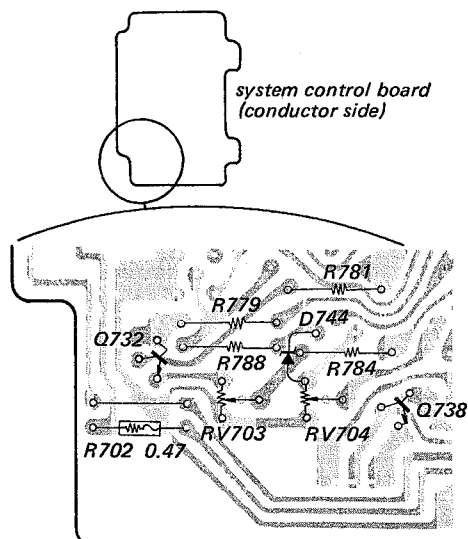

3.2. ELECTRICAL ADJUSTMENTS

Note: The adjustments should be performed in the order given in this service manual.

The adjustments should be performed for both L-CH and R-CH.

Switches and controls should be set as follows unless otherwise specified.

- POWER switch: ON
- TIMER switch: OFF
- MEMORY switch: OFF
- DOLBY NR switch: OFF
- MPX FILTER switch: OFF
- TAPE SELECT EQ switch: TYPE I
- TAPE SELECT BIAS switch: TYPE I
- MIC ATT switch: 0
- PHONES LEVEL control: 0
- REC LEVEL-MIC control: 0
- REC LEVEL-LINE control: 0
- MONITOR switch: TAPE
- REC MASTER control: MAX
- LEVEL ADJUST control: fully clockwise (on the rear panel)

BIAS and EQ switch settings in accordance with tape used are as follows.

Test Tape	EQ switch	BIAS switch
CS-60 (SLH)	TYPE I	TYPE I
CS-70 (DUAD)	TYPE II	TYPE II

Standard Record

Set the REC LEVEL-LINE control for the specified output level. (REC LEVEL-MIC control: 0 position)

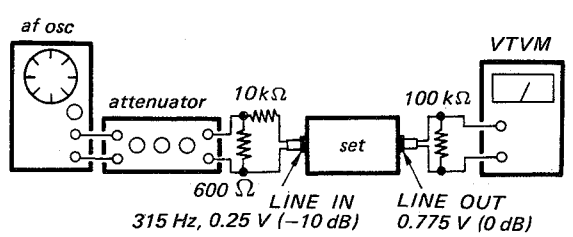

Standard Input Level

	MIC	LINE IN
source impedance	300Ω	10 kΩ
input level	0.77 mV (-60dB)	0.25 V (-10dB)

Standard Output Level

	LINE OUT	HEADPHONES
load impedance	100 kΩ	8Ω
output level	0.775 V (0 dB)	0.12 V (-16 dB)

Monitor Level Adjustment

Setting:

MONITOR switch: SOURCE

Procedure:

1. Mode: record

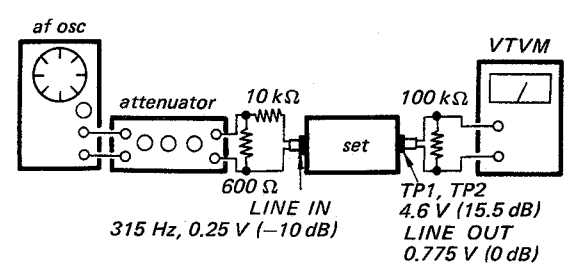

2. Adjust REC LEVEL-LINE control (RV302, 402) for 0.13 V (-15.5 dB) at TP1 or TP2.
3. Adjust RV305 (L-CH) and RV405 (R-CH) for 0.775 V (0 dB) at the L-CH and R-CH LINE OUT.

Specification:

Level difference between channels:
less than 0.5 dB

Adjustment Location:

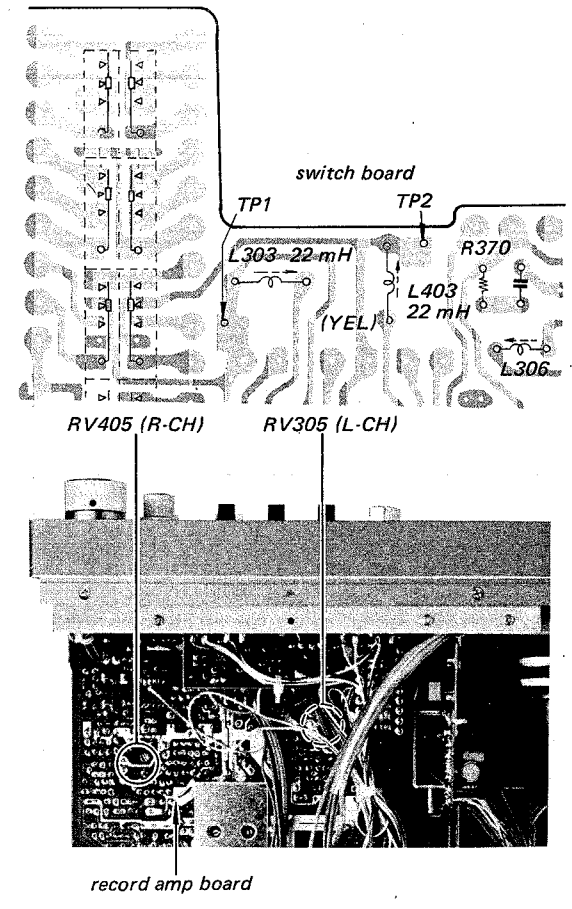

Tape Speed Adjustment

Procedure:

Mode: playback

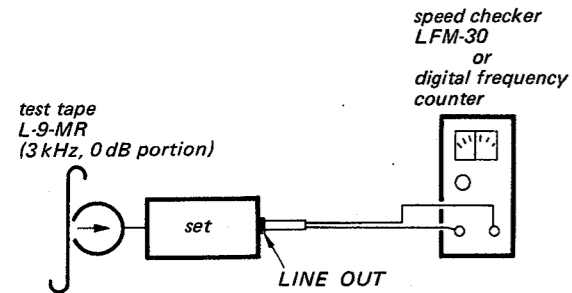

Specification:

Speed Checker	Digital Frequency Counter
± 0.2 %	2,994 – 3,006 Hz

Adjustment Location:

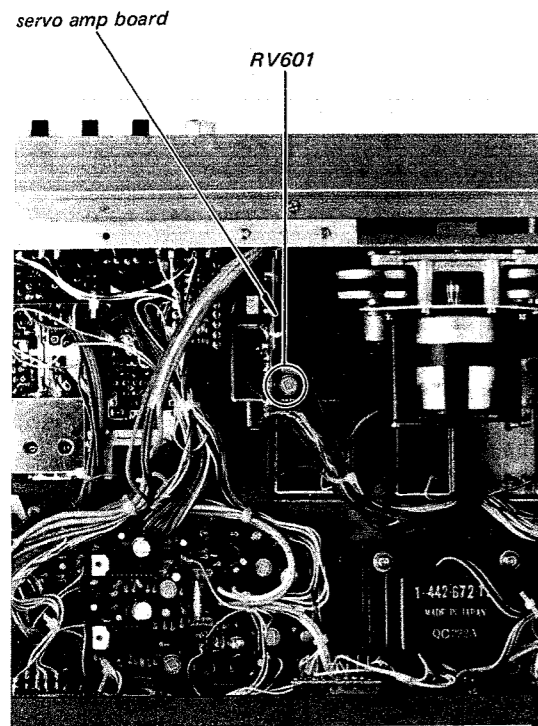

Playback Head Azimuth Adjustment

Procedure:

1. Mode: playback

test tape
L-9-MR
(7 kHz, -10 dB portion)

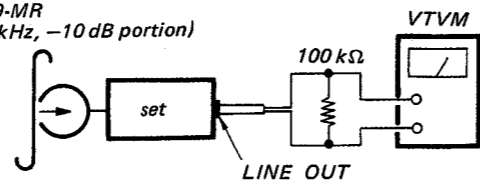

2. Turn the adjustment screw for the maximum level and set it the mechanical mid position of L-CH and R-CH peak position.

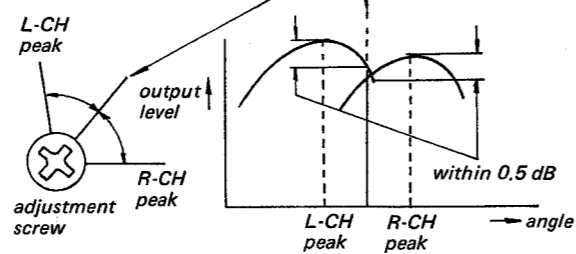

3. Mode: playback

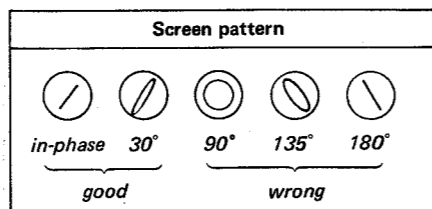
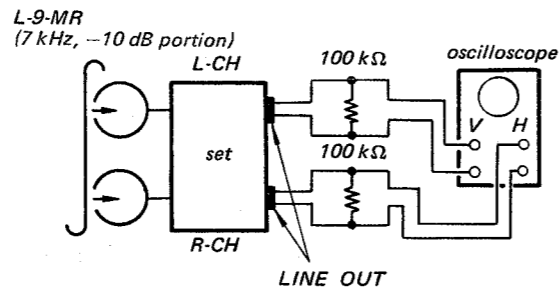

Adjustment Location

(without head cover)

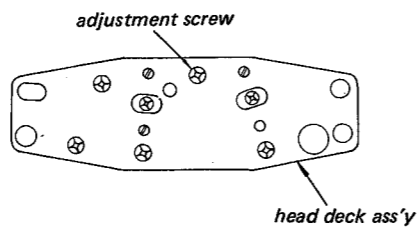

Playback Level Adjustment

Procedure:

test tape
L-9-MR
(315 Hz, 0 dB portion)

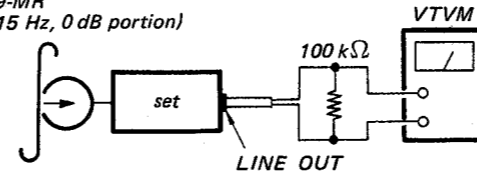

Specification:

LINE OUT Level: 0.73 V – 0.89 V
(0 dB ± 0.5 dB)

Level difference between channels:
less than 0.5 dB

Check that LINE OUT level does not change in playback mode while changing the mode from playback to stop several times.

Adjustment Location:

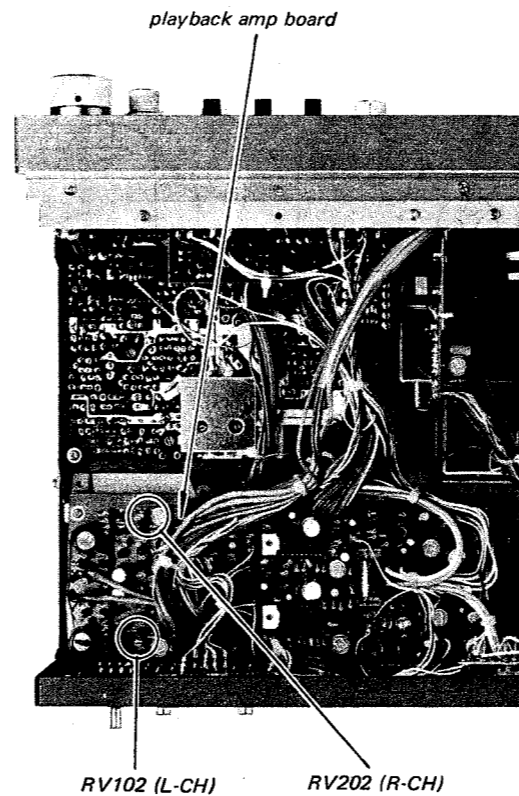

Playback Equalizer Adjustment

Procedure:

test tape
L-9-MR
(315 Hz, 0 dB and
7 kHz, -10 dB portion)

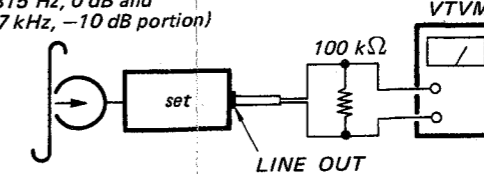

Specification:

7 kHz level difference from 315 Hz: -10.5 dB

Note: After the playback equalizer adjustment make sure that 315 Hz level is between 0.73 V and 0.89 V (0 dB ± 0.5 dB)

Adjustment Location:

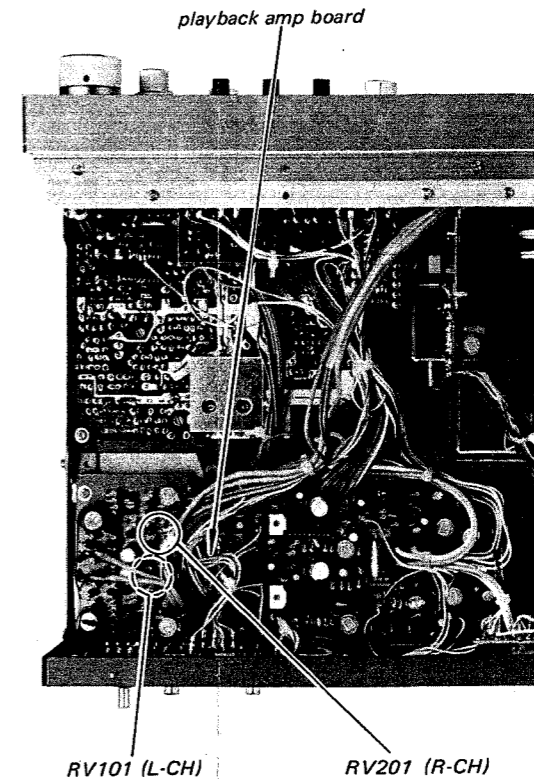

Level Meter Adjustment

Setting:
MONITOR switch: SOURCE

Procedure:
1. Mode: standard record (See page 24).

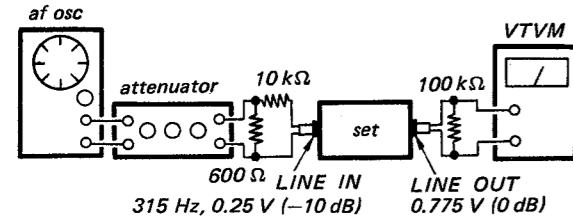

Adjust	VU LEVEL Meter Indication
RV105 (L-CH)	
RV205 (R-CH)	

Adjustment Location:

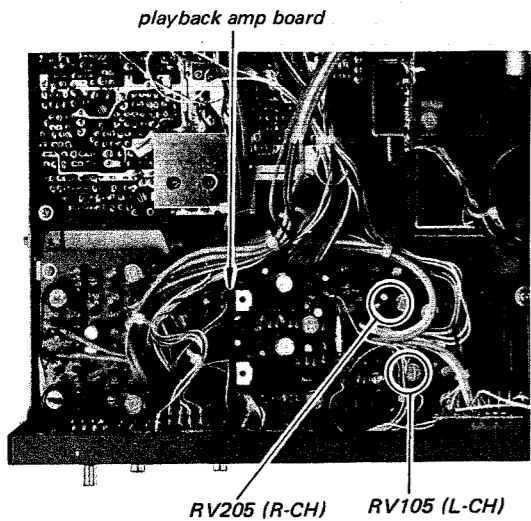

Note: The pointer should move smoothly.

Record Head Azimuth Adjustment

Setting:
REC LEVEL-LINE control:
standard record position (See page 24).

Procedure:
1. Mode: record and simultaneous playback

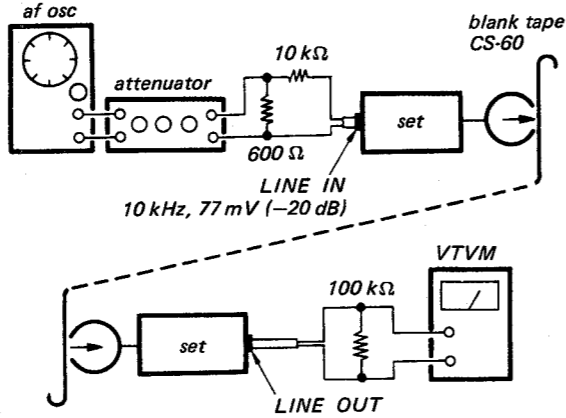

2. Turn the adjustment screw for the maximum level and set it the mechanical mid position of L-CH and R-CH peak position.

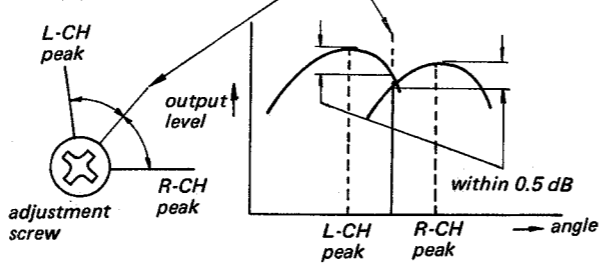

3. Mode: record and simultaneous playback

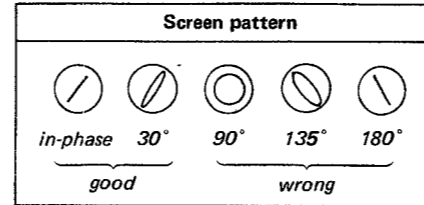
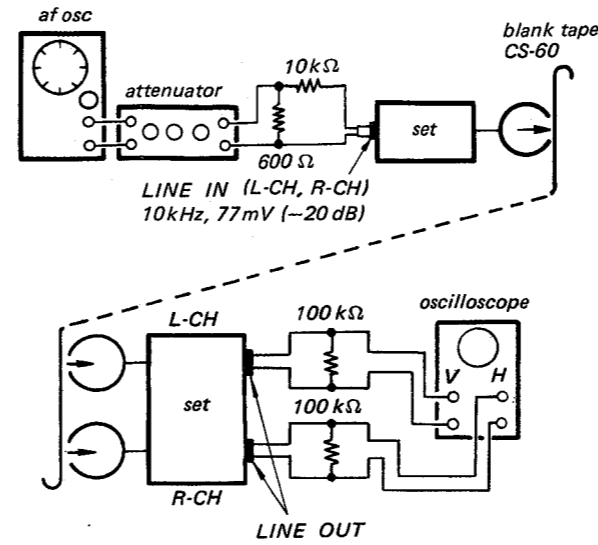

Adjustment Location:

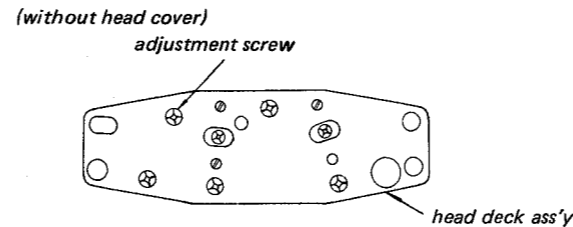

Note: Do not touch the playback head adjustment screws.

Record Level Adjustment

Setting:
REC LEVEL-LINE control:
standard record position (See page 24).

Procedure:
1. Mode: record and simultaneous playback

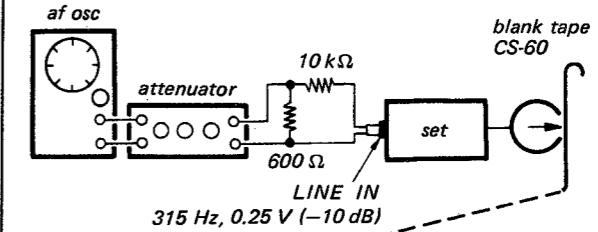

Adjust CAL controls RV306 (L-CH) and RV406 (R-CH) for 0.775 V (0 dB) VTVM reading.

2. Change the blank tape to CS-70 and the TAPE SELECT switch (both EQ and BIAS) to TYPE II, and perform the same record and playback procedure. Measure the LINE OUT level.

Specification:

Blank tape	LINE OUT level
CS-60 (SLH)	0.73 V – 0.84 V (0 dB ± 0.5 dB)
CS-70 (DUAD)	0.71 V – 0.89 V (0 dB ± 0.7 dB)

3. Change the TAPE SELECT switch to TYPE III (EQ) and TYPE I (BIAS), perform the same record and playback procedure. Measure the LINE OUT level.

Specification:

0.57 – 0.67 V (– 2 dB ± 0.7 dB)

Adjustment Location:

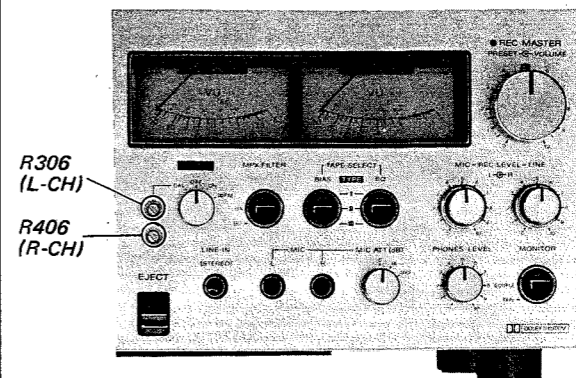

Record Bias Adjustment

Setting:
REC LEVEL-LINE control:
standard record position (See page 24).

Procedure:
1. Mode: record and simultaneous playback

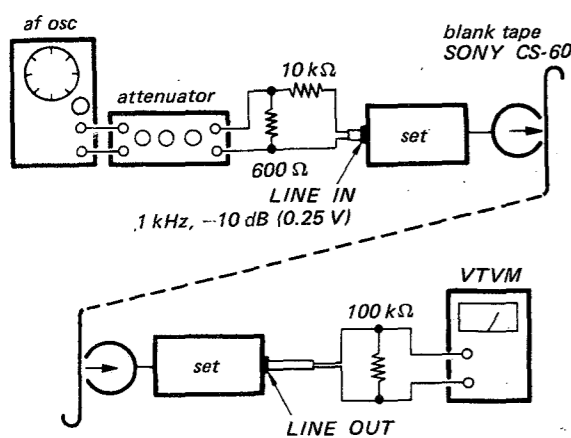

Adjust C344 (L-CH) and C444 (R-CH) for a maximum VTVM reading and note LINE OUT levels.

2. Turn C344 (L-CH) and C444 (R-CH) clockwise to obtain output signal 0.5 dB lower than that obtained in step 1.

Adjustment Location:

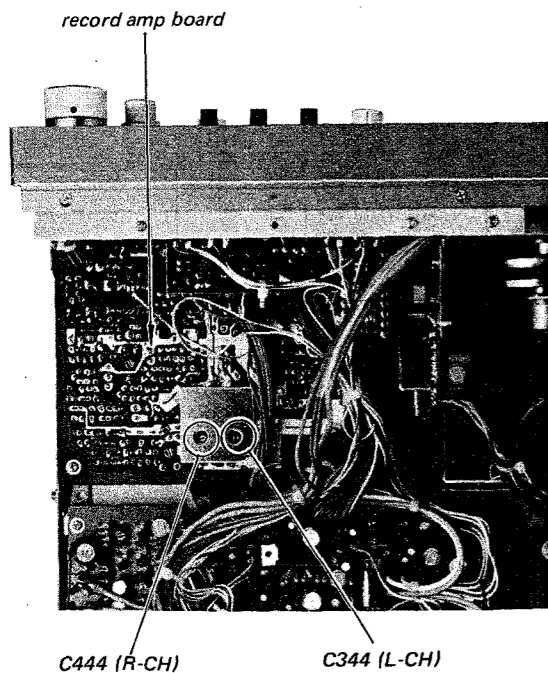

Record Equalizer Adjustment

Setting:
REC LEVEL-LINE control:
standard record position (See page 24).

Procedure:
1. Mode: record and simultaneous playback

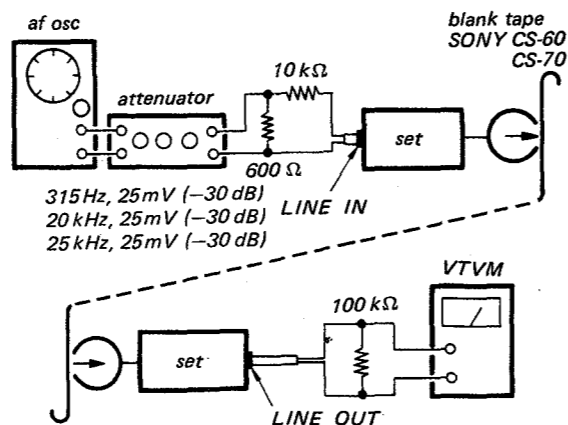

Adjust the coils to obtain 77 mV (-20 dB) LINE OUT level.

TAPE SELECT switch	frequency	blank tape	adjust
TYPE I	20 kHz	CS-60	L305, L405
TYPE II	25 kHz	CS-70	L306, L406
TYPE III	20 kHz	CS-70	L307, L407

Adjustment Location:

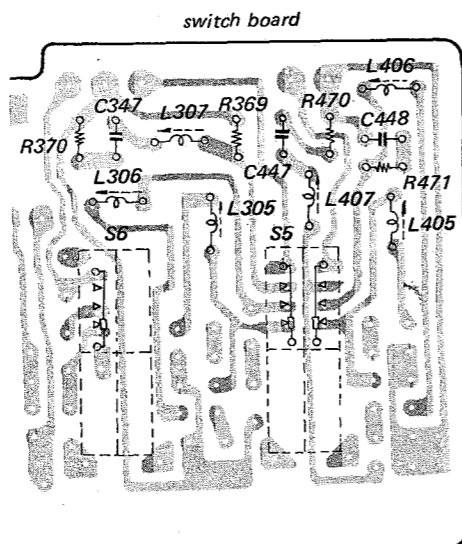

Playback Dolby NR Adjustment

Setting:
REC LEVEL-LINE control:
standard record position (See page 24).

Procedure:
1. Mode: record and simultaneous playback

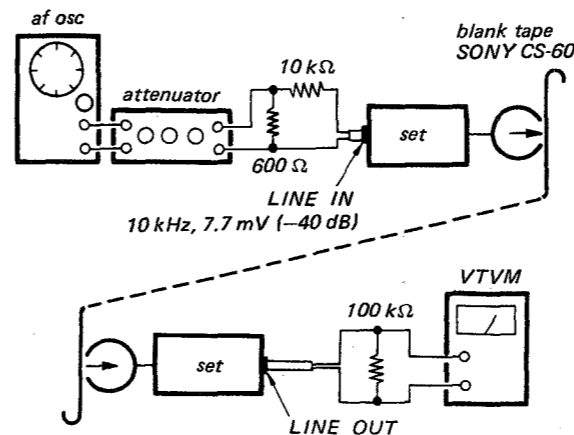

2. Turn the DOLBY NR switch ON and measure the LINE OUT level.

Specification:
LINE OUT level: 24 - 26 mV
(-30 dB ± 0.5 dB)

Adjustment Location:

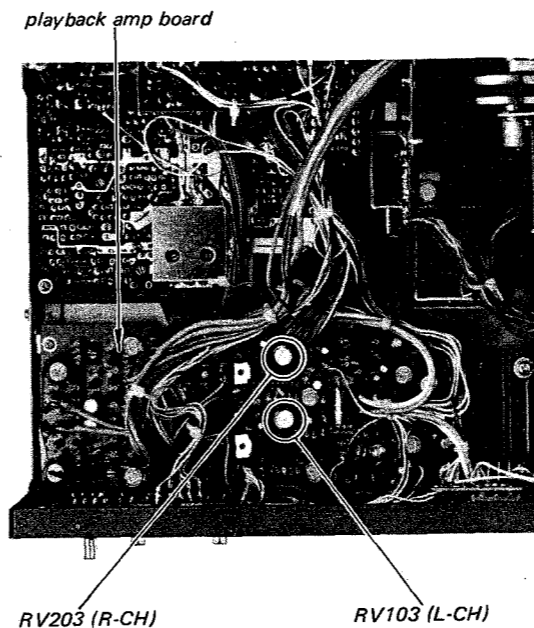

CAL Signal Level Adjustment

Setting:
REC LEVEL-LINE control: Standard record position (See page 24).
MONITOR switch: SOURCE
DOLBY NR switch: CAL

Procedure:

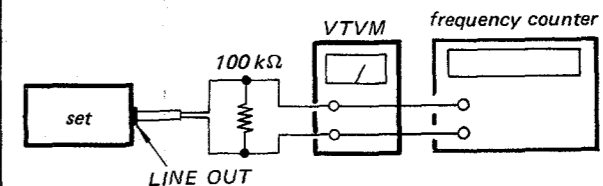

1. Adjust RV501 for the specified LINE OUT level.
2. Make sure that the LINE OUT frequency is specified below.

Specification:
LINE OUT level: 0.73 - 0.89 V
(0 dB ± 0.5 dB)
LINE OUT frequency: 400 Hz ± 80 Hz

Adjustment Location:

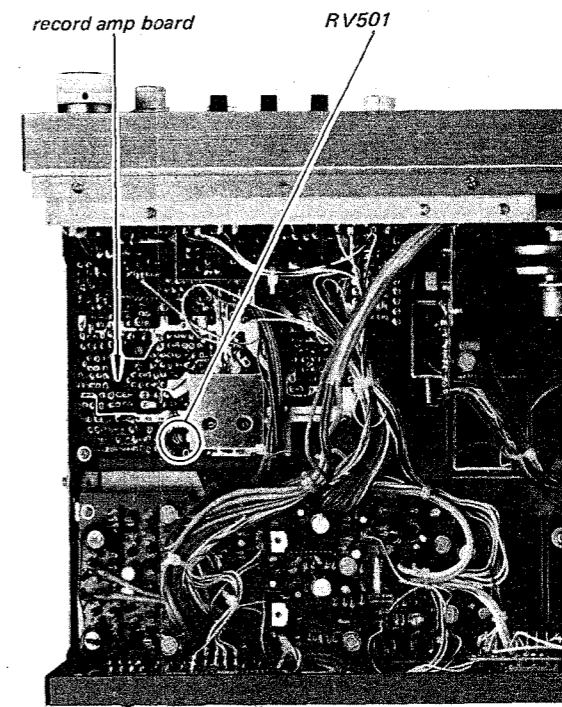

MPX Filter Adjustment

Setting:

MPX FILTER switch: ON
 REC LEVEL-LINE control: Standard record position (See page 24).
 MONITOR switch: SOURCE

Procedure:

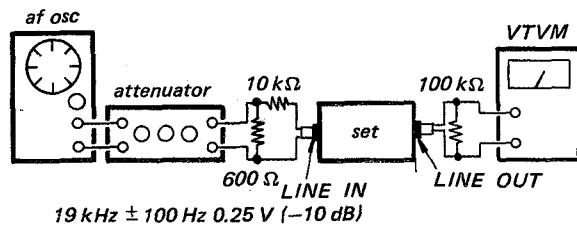

Adjust L303 (L-CH) and L403 (R-CH) for a minimum reading on VTVM.

Adjustment Location:

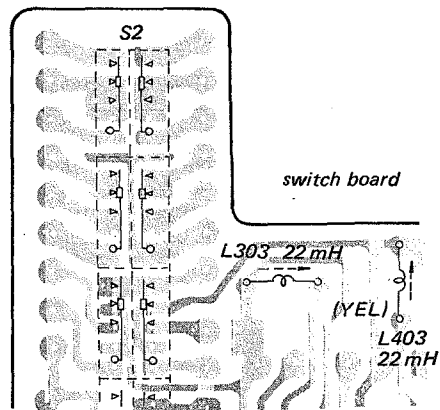
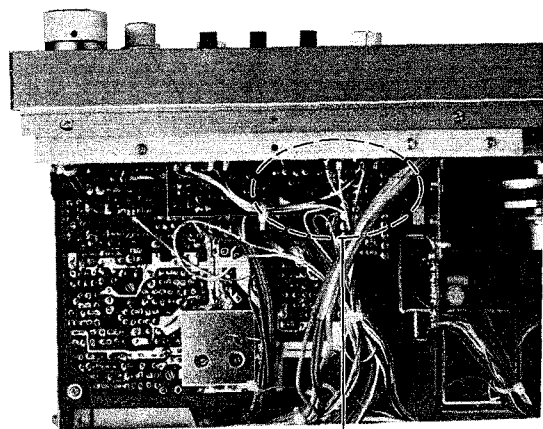

DOLBY FM CAL Adjustment

Setting:

DOLBY NR switch: DOLBY FM
 REC LEVEL-LINE control: Standard record position (See page 24).
 MONITOR Switch: SOURCE

Procedure:

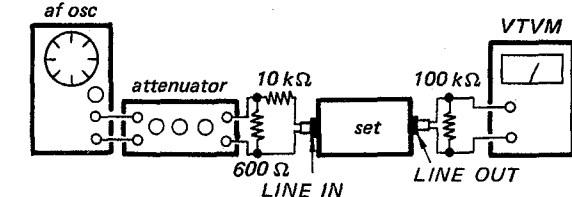

- 315 Hz
 - 10 kHz
1. Adjust RV106 (L-CH) and RV206 (R-CH) for 0.775 V (0 dB) at LINE OUT level at 315 Hz.
 2. Measure the LINE OUT level at 10 kHz.

Specification:

	OSC signal	LINE OUT level
1	315 Hz	0.73 V - 0.89 V (0 dB ± 0.5 dB)
2	10 kHz	1.4 V - 2.2 V (7 dB ± 2 dB)

Adjustment Location:

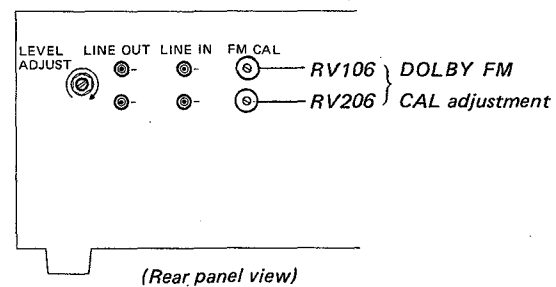

4-1. SEMICONDUCTORS

Replacement Semiconductors:

IC101, 201, 301, 401: CX064
 IC102, 202: TA7066P
 IC601: CX065A
 IC701: CX738A
 Q101, 201: 2SK43
 Q102, 103, 109, Q202, 203, 209, Q301, 302, 308, Q401, 402, 408
 Q104 ~ 108, 111, 112, Q204 ~ 208, 211, 212, Q303 ~ 307, 403 ~ 407, Q309, 409, 501, 503 ~ 505, 507, 508, Q601, 602, 701, 703, 704, Q706 ~ 708, 710 ~ 712, 714 ~ 716, Q718 ~ 720, 722, 724, 725, 727, Q729 ~ 733, 735, 737, 738, Q740 ~ 744, 746
 2SC634A
 Q110, 210: 2SC1474
 Q502: 2SC1475
 Q713, 717
 Q734
 Q506: 2SA678
 Q603, 702, 728 } 2SC1173
 Q736, 739 }
 Q705, 709 } 2SC1061
 Q721 }
 Q723, 726: 2SC1124
 Q745: TSP603
 D101, 102, 201, 202, D602, 716, 726, 735 } 1T22A
 D501, 503, 505 ~ 508, D601, 712 ~ 715, 717, 718, D723, 724, 727, 729, 733, Q736 ~ 743 } 1S1555
 D701, 702, 704 ~ 709, D719 ~ 722, 725, 731 } 10E2
 D734 }
 D502: EQB01-21
 D504: EQA01-05R
 D703: EQB01-06
 D710: EQB01-12Z
 D711: EQB01-10
 D730, 732: EQB01-22
 D744: EQB01-07
 D603: KB369
 D728: MV203V
 D728: MV203V

Original Semiconductors:

IC101, 201, 301, 401: CX064
 IC102, 202: TA7066P
 IC601: CX065
 IC701: CX738A
 Q101, 201: 2SK43
 Q102, 103, 109, Q202, 203, 209, Q301, 302, 308, Q401, 402, 408
 Q104 ~ 108, 111, 112, Q204 ~ 208, 211, 212, Q303 ~ 307, 403 ~ 407, Q309, 409, 501, 503 ~ 505, 507, 508, Q507 } 2SC634A
 D101, 102, 201, 202, D602, 716, 726, 735 } 1T22
 D501, 503, 505 ~ 508, D601, 712 ~ 715, 717, 718, D723, 724, 727, 729, 733, D736 ~ 743 } 1T40
 D502: EQA01-21R
 D504: EQA01-05R
 D701, 702, 704 ~ 709, D719 ~ 722, 725, 731 } SIB01-02
 D734 }
 D703: EQA01-06S
 D710: EQA01-12
 D711: EQA01-10
 D730, 732: EQA01-22R
 D744: EQA01-07S
 D603: KB369
 D728: MV203V

4-2. MOUNTING DIAGRAM

- Conductor Side -

EL-7 EL-7

D	Q, IC
705	705 702
709	704 708 701 706
710	703
703	745
728	711
708	707
710	712
707	706
738	738
743	713
705	744 741
704	742
702	737
701	735
739	740
741	718
713	729 728
725	724
740	719
716	720 719
721	721
717	723
727	722
719	722 701
721	727
722	720
724	715
718	726
723	717
714	725
729	716
733	730 733
732	731 734
737	714
732	732
730	738 735
731	712
736	739 736

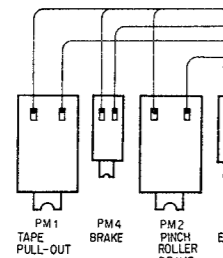
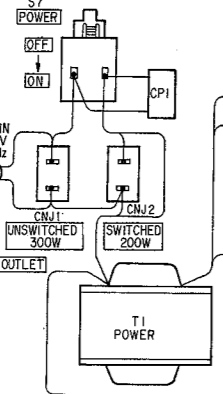
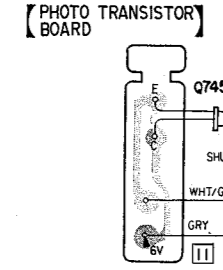

PM1: Tape pulled out in PAUSE mode.
PM2: Pinch roller pressed against capstan in forward mode.
PM4: Brake released when ON.

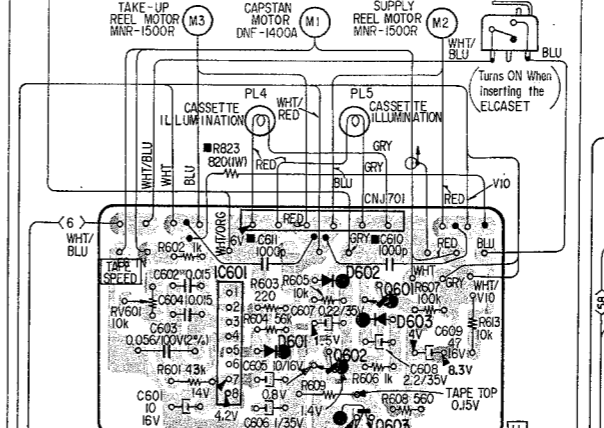
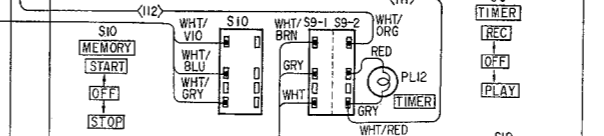
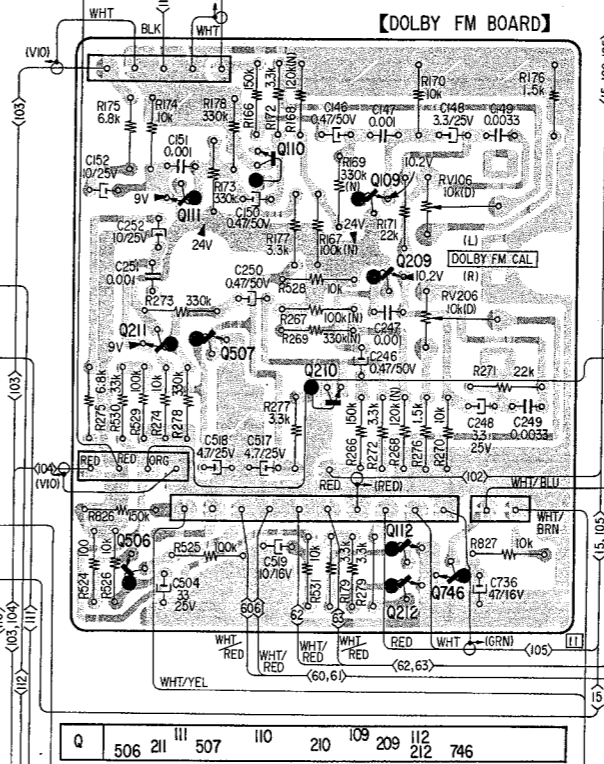
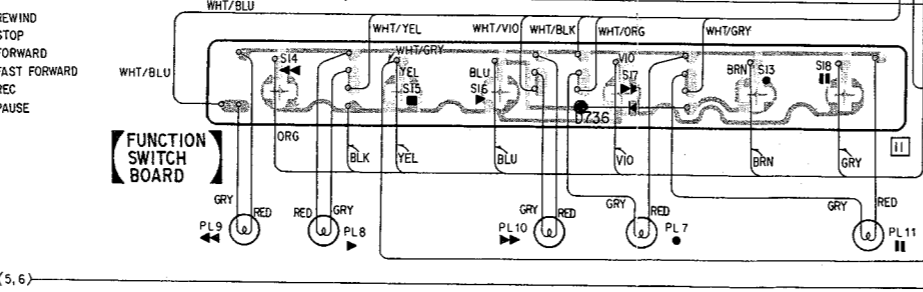
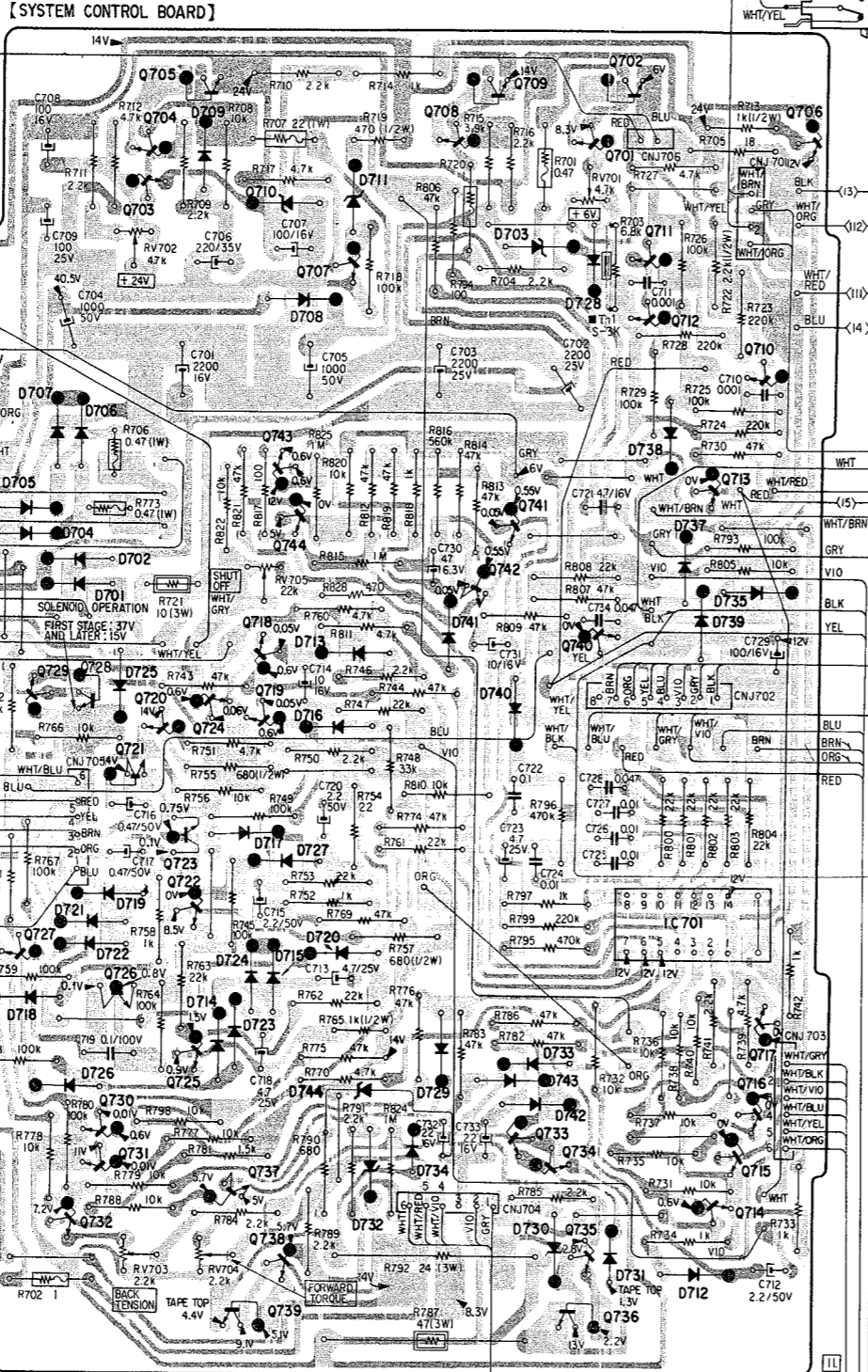

Q, IC	IC601	602	603	601
D	601	602	603	603

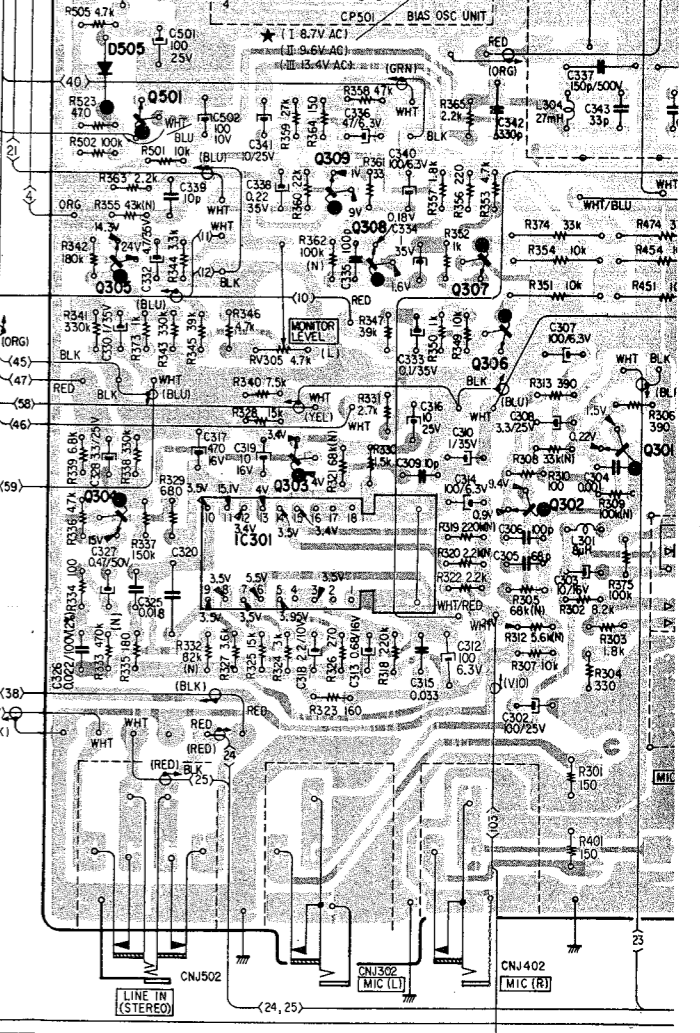
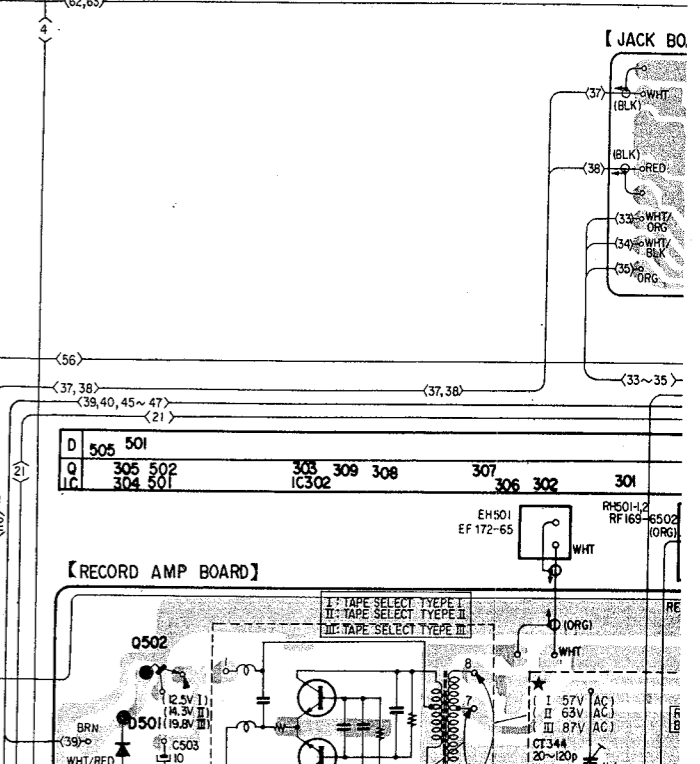
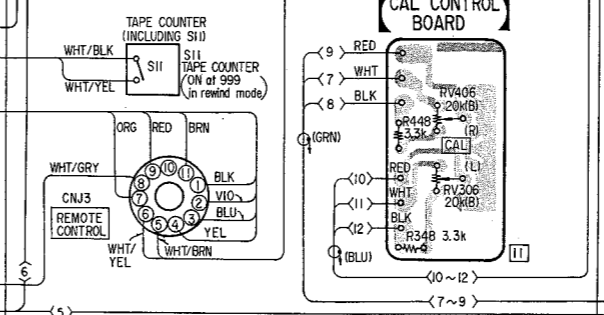

Note:
 ● indicates lead wire connection on the conductor side.
 ○ indicates lead wire connection through the component side.
 ■ : part mounted on the conductor side.

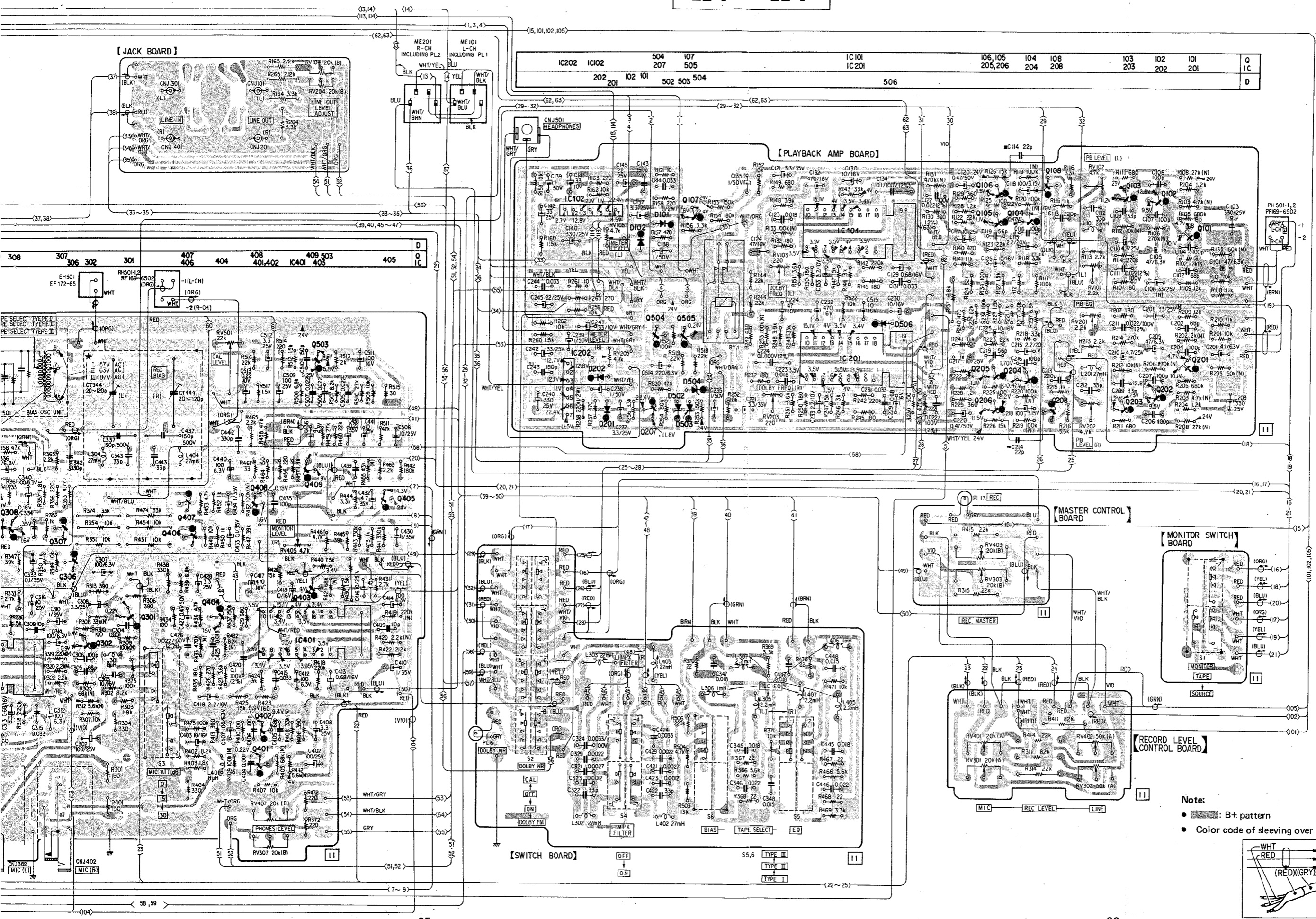

IC202	IC102	504	107	IC101	106,105	104	108	103	102	101	Q
202	201	207	505	IC201	205,206	204	208	203	202	201	IC
		502	503	504							D
				506							

Note:
 • B+ pattern
 • Color code of sleeving over the end of the jacket.

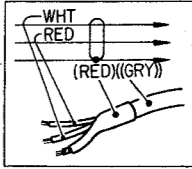

4-3. SCHEMATIC DIAGRAM — Amplifier Section —

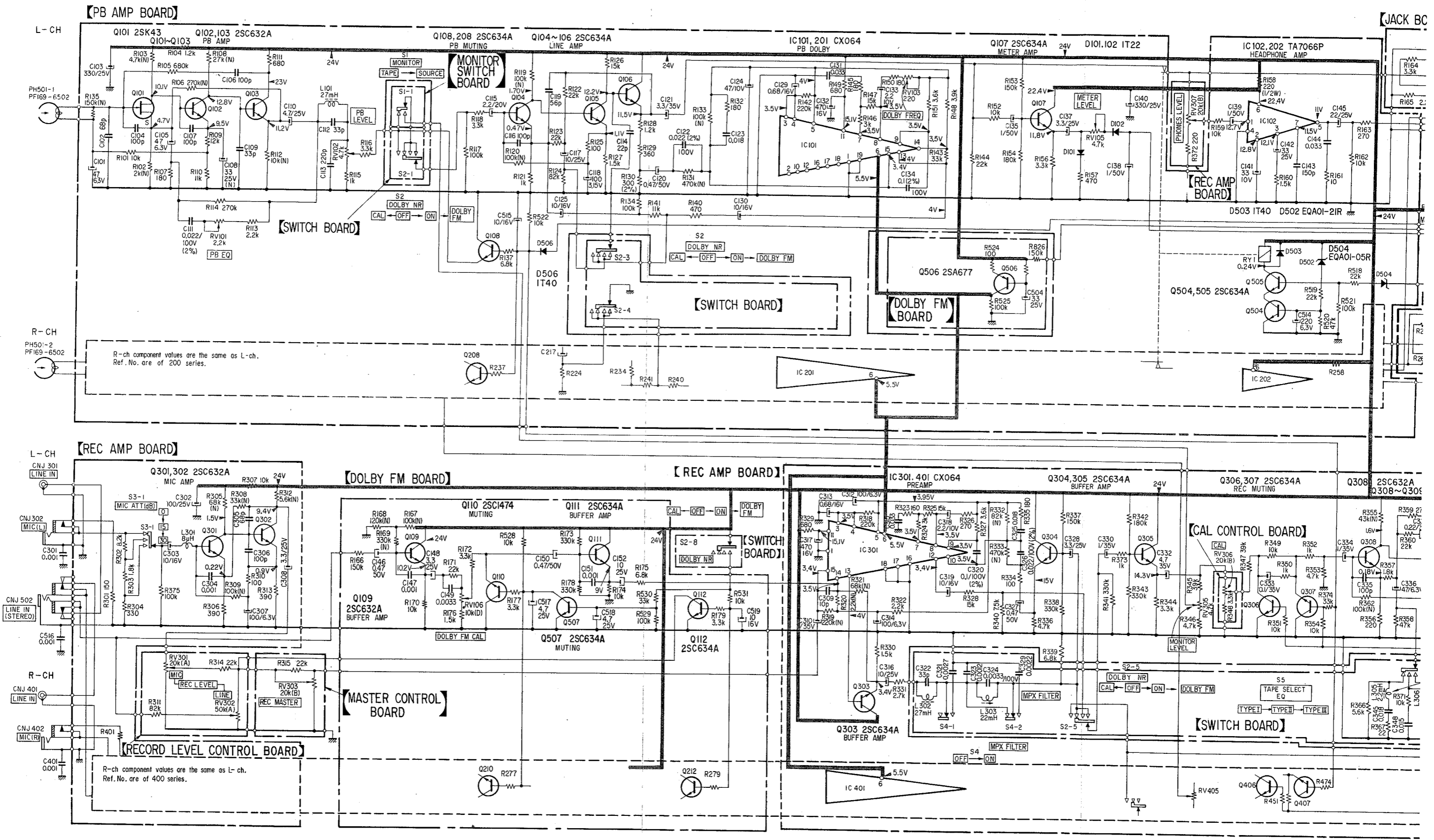

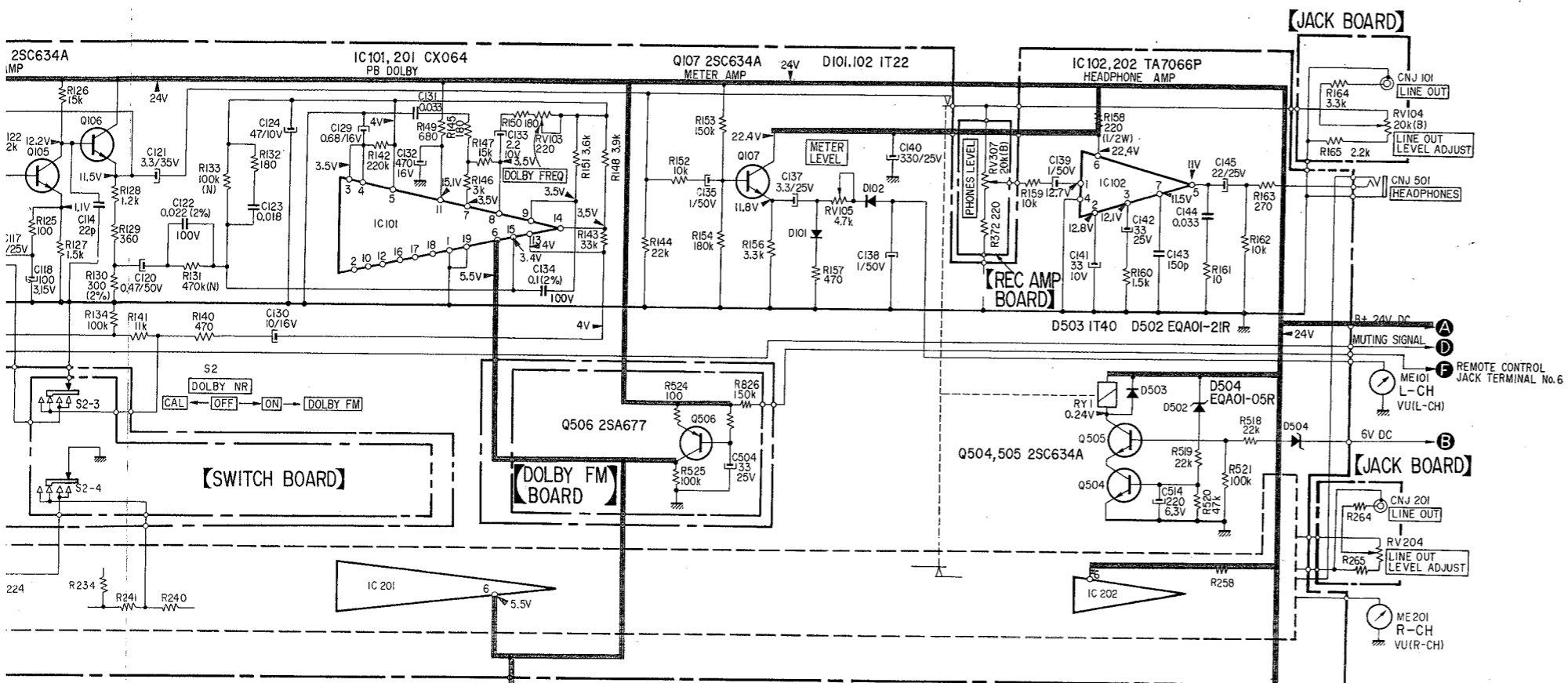

Note:

- PB: playback
- REC: record
- All capacitors are in μF unless otherwise noted. $\text{pF} = \mu\mu\text{F}$ 50 WV or less are not indicated except for electrolytics.
- All resistors are in ohms, $\frac{1}{4}\text{W}$ unless otherwise noted. $\text{k}\Omega = 1000\Omega$; $\text{M}\Omega = 1000\text{k}\Omega$
- All adjustable resistors have characteristic curve B.
- (N) : low-noise capacitor and resistor.
- 2% indicates component tolerance.
- : B+ bus.
- : panel designation.
- : adjustment for repair.
- : chassis ground.
- Voltages are dc with respect to ground unless otherwise noted.
- Readings are taken in stop mode with a VOM (20 $\text{k}\Omega/\text{V}$).
- Voltage variations may be noted due to normal production tolerances.
- Switch

Ref No.	Switch	Position
S1	MONITOR	TAPE
S2	DOLBY NR	OFF
S3	MIC ATT	0dB
S4	MPX FILTER	OFF
S5	TAPE SELECT - EQ	I
S6	TAPE SELECT - BIAS	I

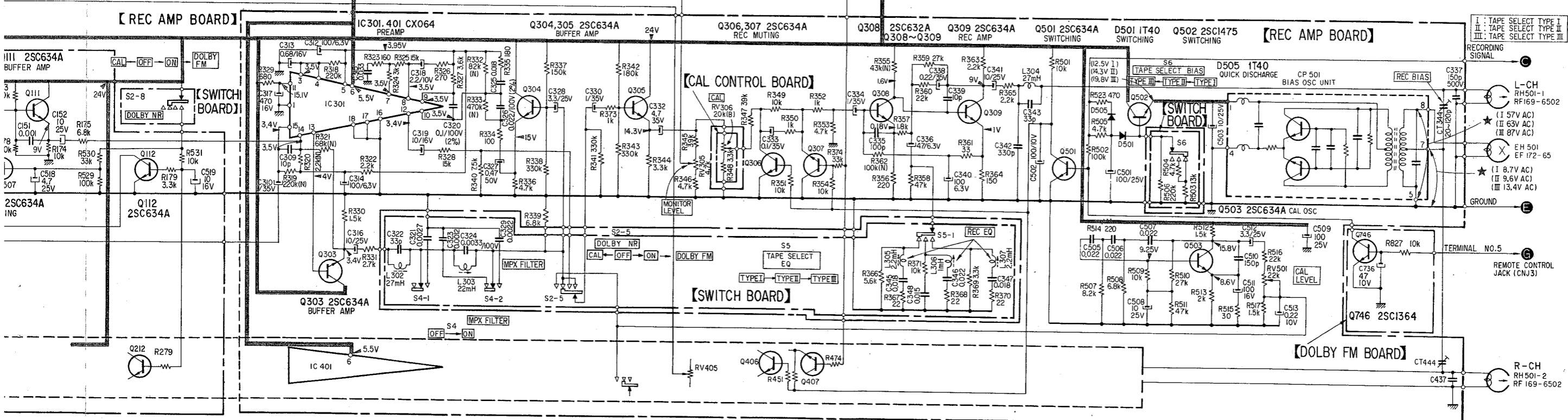

4-4. SCHEMATIC DIAGRAM – System Control Section –

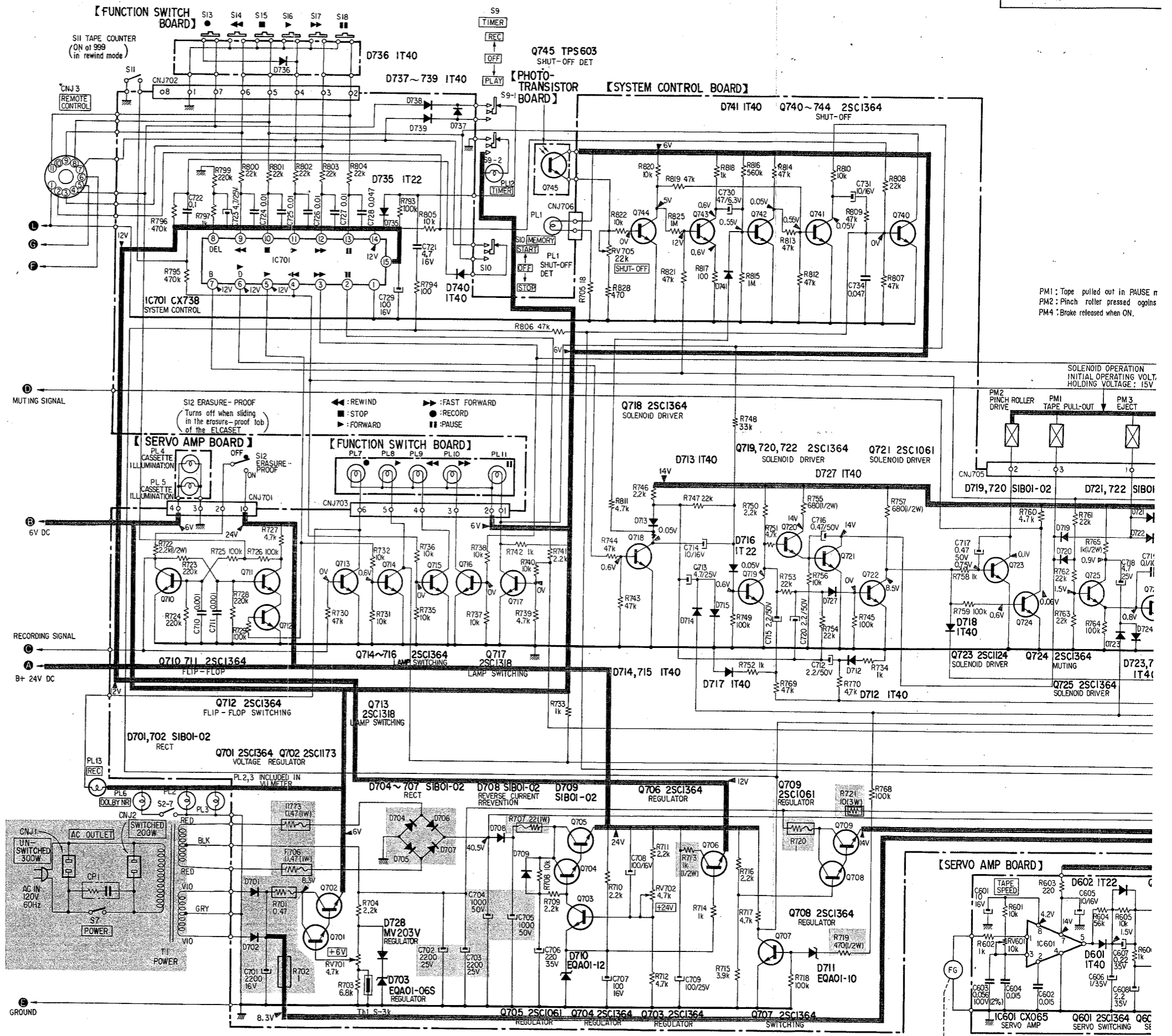

Note:

- All capacitors are in μF unless otherwise noted. $\text{pF} = \mu\mu\text{F}$ 50 WV or less are not indicated except for electrolytics.
- All resistors are in ohms, $\frac{1}{4}\text{W}$ unless otherwise noted. $\text{k}\Omega = 1000\Omega$; $\text{M}\Omega = 1000\text{k}\Omega$
- All adjustable resistors have characteristic curve B.
- : nonflammable resistor.
- : fusible resistor.
- 2% indicates component tolerance.
- : B+ bus.
- : panel designation.
- : adjustment for repair.
- : chassis ground.
- Voltages are dc with respect to ground unless otherwise noted.
- Readings are taken in stop mode with a VOM (20 $\text{k}\Omega/\text{V}$).
- Voltage variations may be noted due to normal production tolerances.
- Switch

Ref. No.	Switch	Position
S7	POWER	OFF
S9	TIMER	OFF
S10	MEMORY	OFF
S11	TAPE COUNTER	OFF
S12	ERASURE PROOF	OFF
S13	RECORD	OFF
S14	REWIND	OFF
S15	STOP	OFF
S16	FORWARD	OFF
S17	FAST FORWARD	OFF
S18	PAUSE	OFF
S19	CASSETTE DETECT	OFF

Note: The components identified by shading are critical for safety. Replace only with part number specified.

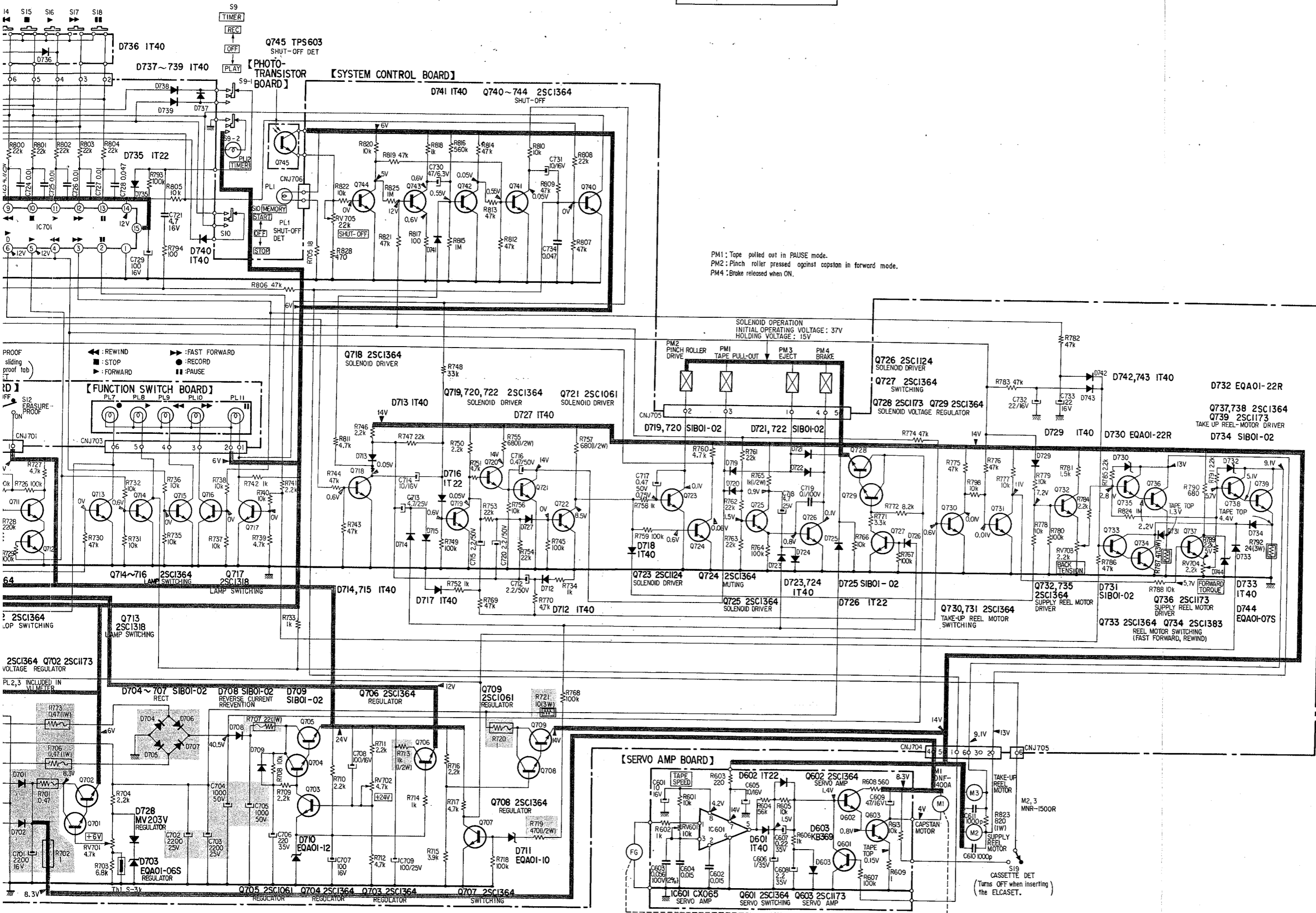

PM1: Tape pulled out in PAUSE mode.
 PM2: Pinch roller pressed against copstan in forward mode.
 PM4: Brake released when ON.

A

B

C

D

E

5-1.

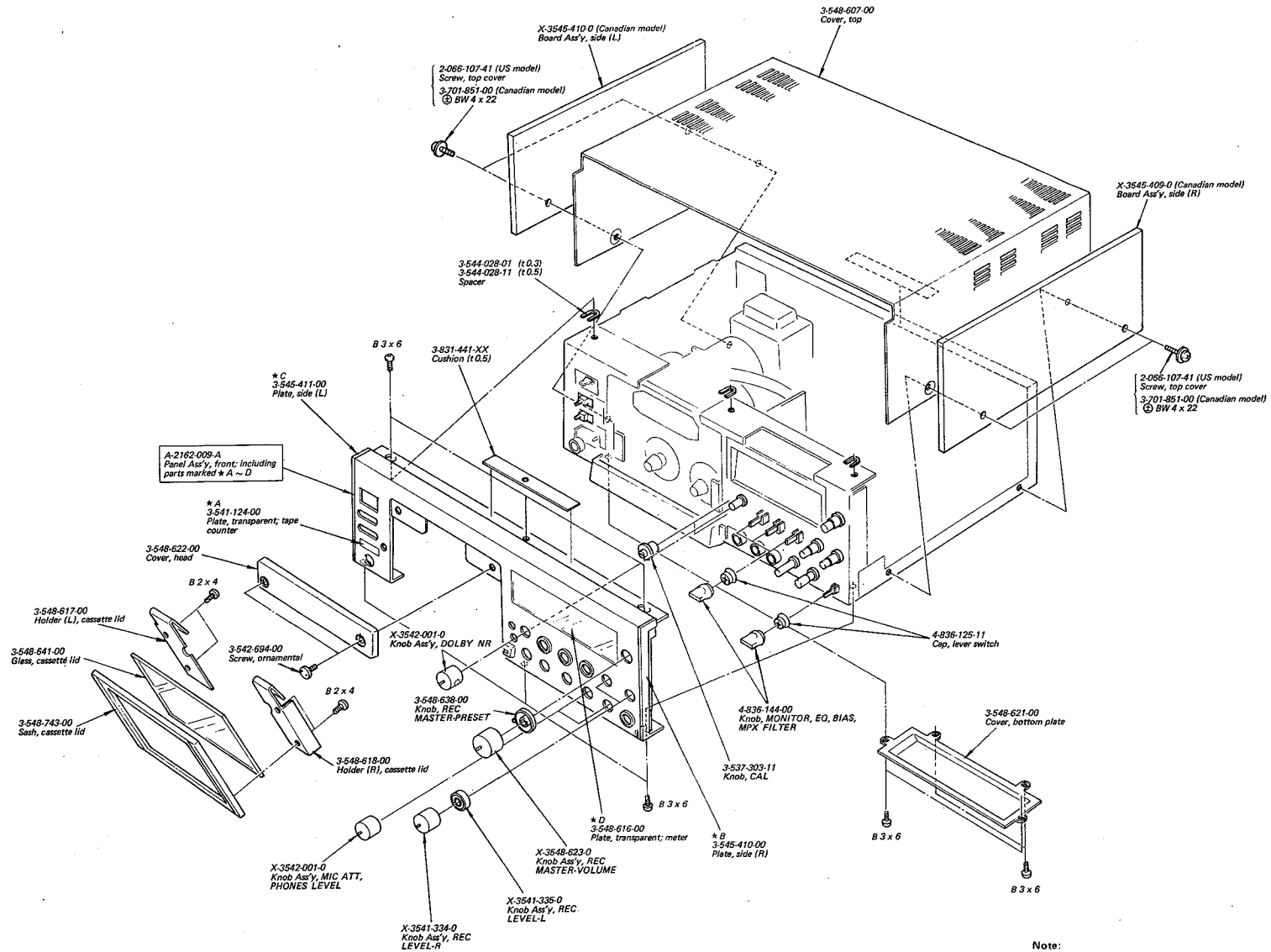
SECTION 5
EXPLODED VIEWS

Note:

- Items with no part number and/or no description are not stocked because they are seldom required for routine service.
- All screws are Phillips (cross recess) type unless otherwise noted.
(-) = slotted head
- Circled letters (A to Z) are applicable to European models only.

EL-7

A B C D E

5-2.

1

2

44

3

4

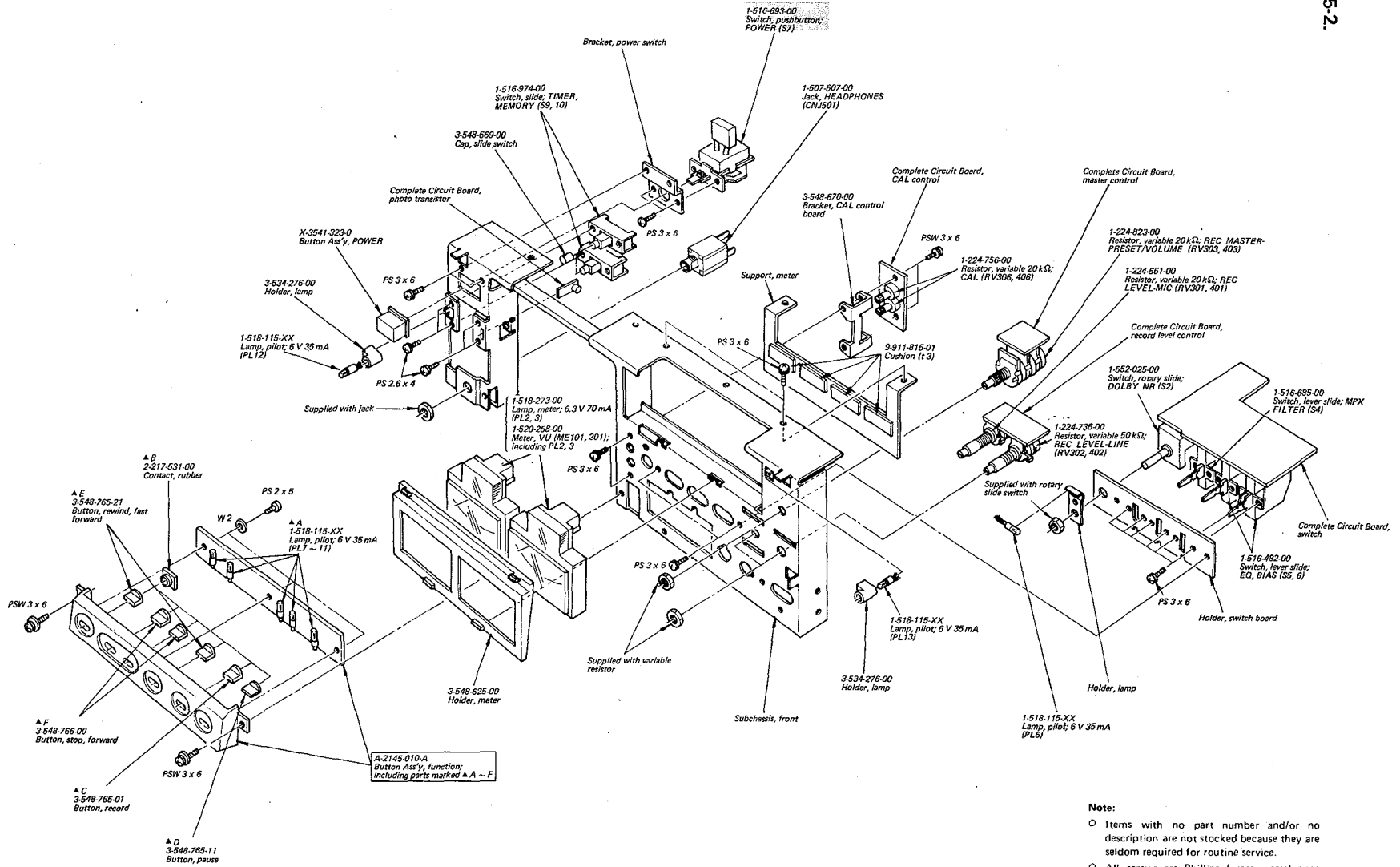

Note:

- Items with no part number and/or no description are not stocked because they are seldom required for routine service.
- All screws are Phillips (cross recess) type unless otherwise noted.
- (-) = slotted head
- Circled letters (A to Z) are applicable to European models only.

Note: The components identified by shading are critical for safety. Replace only with part number specified.

A

B

C

D

E

5-3.

1

2

3

4

- 45 -

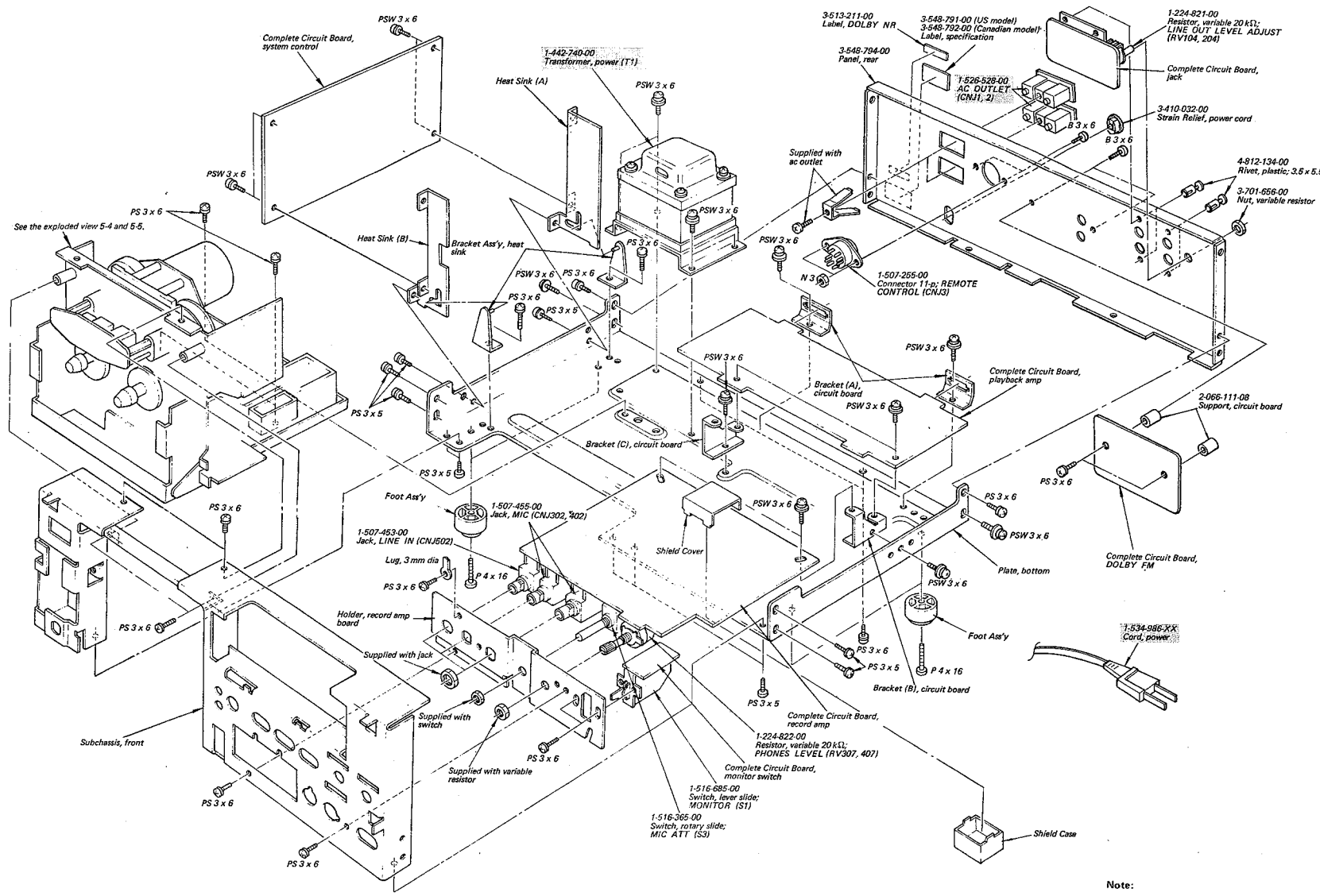

Note: The components identified by shading are critical for safety. Replace only with part number specified.

Note:

- Items with no part number and/or no description are not stocked because they are seldom required for routine service.
- All screws are Phillips (cross recess) type unless otherwise noted.
- (-) = slotted head
- Circled letters (A) to (Z) are applicable to European models only.

EL-7

1

2

3

4

46

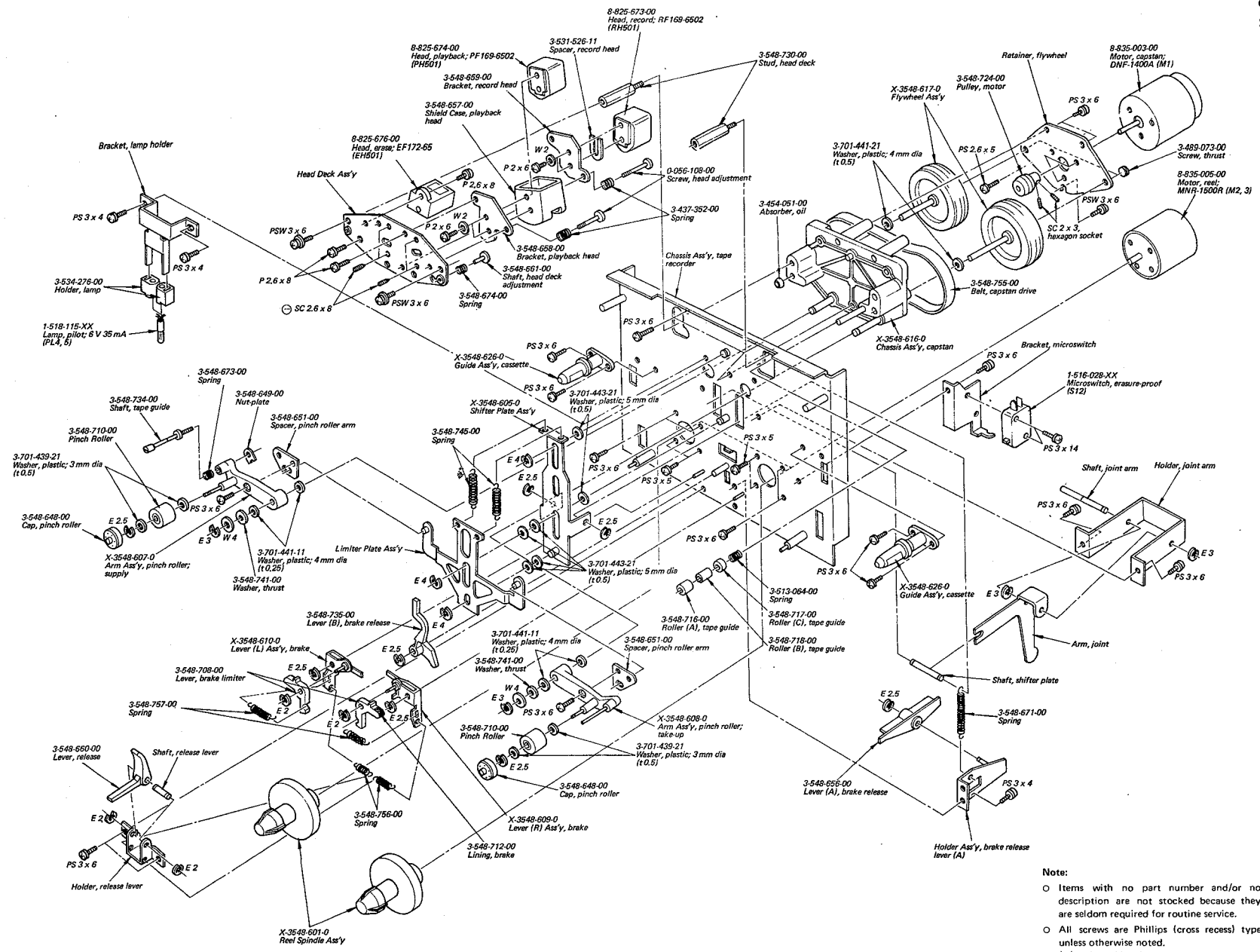

Note:

- Items with no part number and/or no description are not stocked because they are seldom required for routine service.
- All screws are Phillips (cross recess) type unless otherwise noted.
- (-) = slotted head
- Circled letters (A) to (Z) are applicable to European models only.

A

B

C

D

E

55.

1

2

3

4

- 47 -

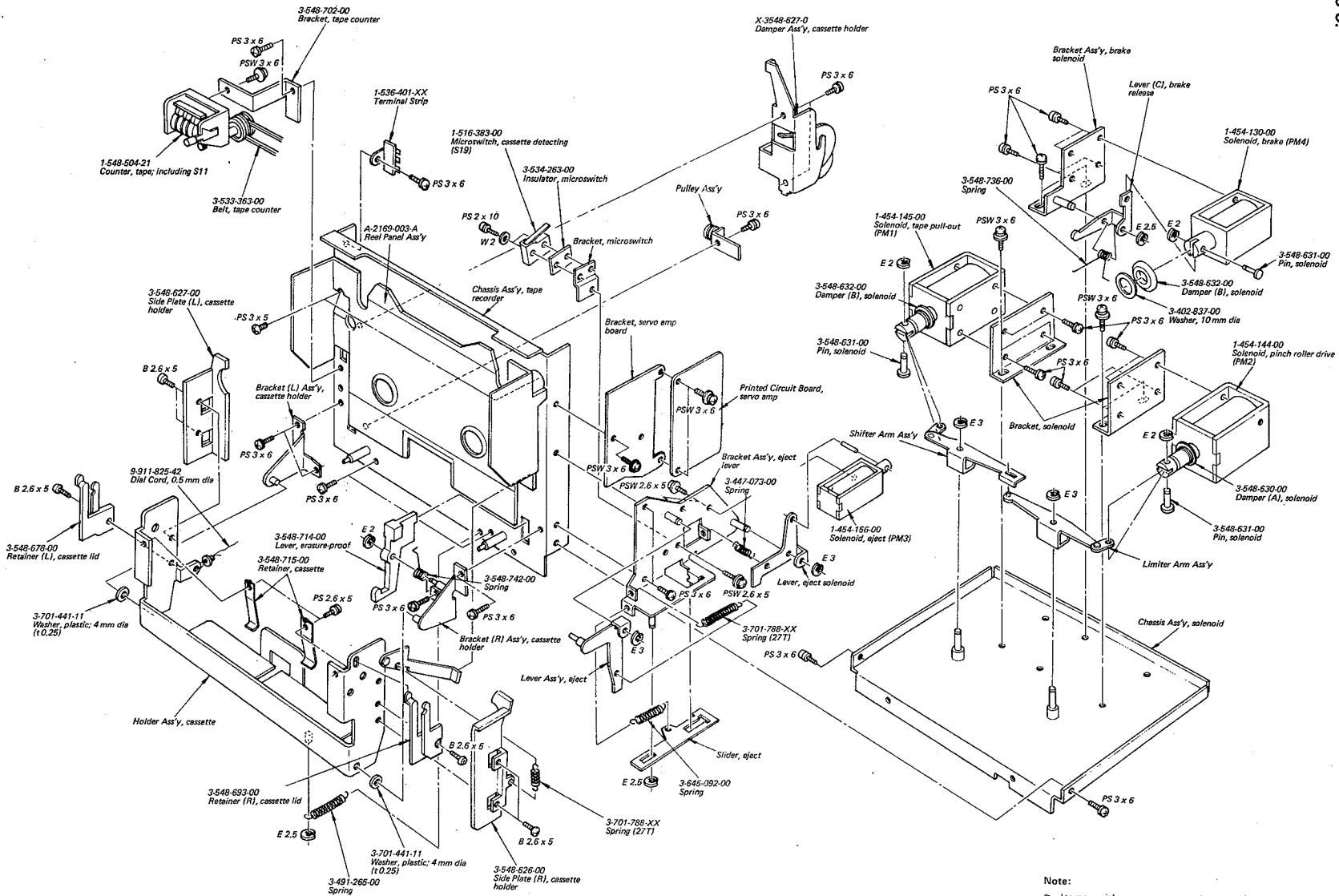

Note:

- Items with no part number and/or no description are not stocked because they are seldom required for routine service.
- All screws are Phillips (cross recess) type unless otherwise noted.
(-) = slotted head
- (DOT) shows the number of coils in spring.
- Circled letters (A) to (Z) are applicable to European models only.

EL-7

SECTION 6 ELECTRICAL PARTS LIST

<u>Ref. No.</u>	<u>Part No.</u>	<u>Description</u>	<u>Ref. No.</u>	<u>Part No.</u>	<u>Description</u>
SEMICONDUCTORS					
Transistors					
Q101, 201		2SK43	⇒ Q735		2SC634A
Q102, 202		2SC632A	Q736		2SC1173
Q103, 203			⇒ Q737, 738		2SC634A
Q104 ~ 108		2SC634A	Q739		2SC1173
Q204 ~ 208			⇒ Q740 ~ 744		2SC634A
Q109, 209		2SC632A	Q745		TPS603
Q110, 210		2SC1474	⇒ Q746		2SC634A
Q111, 211		2SC634A	ICs		
Q112, 212			IC101, 201		CX064
Q301, 401		2SC632A	IC102, 202		TA7066P
Q302, 402			IC301, 401		CX064
Q303 ~ 307		2SC634A	IC601		CX065
Q403 ~ 407			IC701		CX738
Q308, 408		2SC632A	Diodes		
Q309, 409		2SC634A	⇒ D101, 201		1T22A
Q501		2SC634A	⇒ D102, 202		
Q502		2SC1475	⇒ D501		1S1555
Q503 ~ 505		2SC634A	⇒ D502		EQB01-21
⇒ Q506		2SA678	⇒ D503		1S1555
⇒ Q507		2SC634A	⇒ D504		EQB01-05
⇒ Q601, 602		2SC634A	⇒ D505, 506		1S1555
⇒ Q603		2SC1173	⇒ D601		1S1555
⇒ Q701		2SC634A	⇒ D602		1T22A
Q702		2SC1173	D603		KB369
⇒ Q703, 704		2SC634A	⇒ D701, 702		10E2
Q705		2SC1061	⇒ D703		EQB01-06
⇒ Q706 ~ 708		2SC634A	⇒ D704 ~ 707		10E2
Q709		2SC1061	⇒ D708, 709		10E2
⇒ Q710 ~ 712		2SC634A	⇒ D710		EQB01-12Z
⇒ Q713		2SC1475	⇒ D711		EQB01-10
⇒ Q714 ~ 716		2SC634A	⇒ D712 ~ 715		1S1555
⇒ Q717		2SC1475	⇒ D716		1T22A
⇒ Q718 ~ 720		2SC634A	⇒ D717, 718		1S1555
Q721		2SC1061	⇒ D719 ~ 722		10E2
⇒ Q722		2SC634A	⇒ D723, 724		1S1555
Q723		2SC1124	⇒ Due to replacement parts, the descriptions are affarent on the schematic diagram.		
⇒ Q724, 725		2SC634A	Note: The components identified by shading are critical for safety. Replace only with part number specified.		
Q726		2SC1124			
⇒ Q727		2SC634A			
Q728		2SC1173			
⇒ Q729 ~ 733		2SC634A			
⇒ Q734		2SC1475			

<u>Ref. No.</u>	<u>Part No.</u>	<u>Description</u>	<u>Ref. No.</u>	<u>Part No.</u>	<u>Description</u>
⇒ D725		10E2	C112, 212	1-107-073-11	33 p silvered mica
⇒ D726		1T22A	C113, 213	1-107-093-11	220 p silvered mica
⇒ D727		1S1555	C114, 214	1-102-967-11	22 p ceramic
⇒ D728		MV-203V	C115, 215	1-131-196-11	2.2 20 V tantalum
⇒ D729		1S1555	C116, 216	1-107-131-11	100 p silvered mica
⇒ D730		EQB01-22	C117, 217	1-121-398-11	10 25 V
⇒ D731		10E2	C118, 218	1-131-187-11	100 3.15 V tantalum
⇒ D732		EQB01-22	C119, 219	1-107-079-11	56 p silvered mica
⇒ D733		1S1555	C120, 220	1-121-726-11	0.47 50 V
⇒ D734		10E2	C121, 221	1-131-218-11	3.3 35 V tantalum
⇒ D735		1T22A	C122, 222	1-130-072-11	0.022 ±2% 100 V film
⇒ D736 ~ 743		1S1555	C123, 223	1-108-585-12	0.018 mylar
⇒ D744		EQB01-07	C124, 224	1-121-352-11	47 10 V
			C125, 225	1-121-651-11	10 16 V
			C129, 229	1-127-379-11	0.68 16 V solid aluminum
			C130, 230	1-121-651-11	10 16 V
			C131, 231	1-108-591-12	0.033 mylar
			C132, 232	1-121-426-11	470 16 V
			C133, 233	1-127-024-11	2.2 10 V solid aluminum
			C134, 234	1-130-071-11	0.1 ±2% 100 V film
			C135, 235	1-121-391-11	1 50 V
			C137, 237	1-121-392-11	3.3 25 V
			C138, 238	1-121-391-11	1 50 V
			C139, 239	1-121-391-11	1 50 V
			C140, 240	1-121-654-11	330 25 V
			C141, 241	1-121-402-11	33 10 V
			C142, 242	1-121-404-11	33 25 V
			C143, 243	1-107-135-00	150 p silvered mica
			C144, 244	1-108-591-12	0.033 mylar
			C145, 245	1-121-480-11	22 25 V
			C146, 246	1-121-726-11	0.47 50 V
			C147, 247	1-108-227-12	0.001 mylar
			C148, 248	1-121-392-11	3.3 25 V
			C149, 249	1-108-567-12	0.0033 mylar
			C150, 250	1-121-726-11	0.47 50 V
			C151, 251	1-108-227-12	0.001 mylar
			C152, 252	1-121-398-11	10 25 V
			C301, 401	1-101-455-11	0.001 ceramic
			C302, 402	1-121-416-11	100 25 V
			C303, 403	1-121-916-11	10 16 V
			C304, 404	1-108-227-12	0.001 mylar
			C305, 405	1-107-081-11	68 p silvered mica

Thermistor

Th1 1-800-200-00 S-3K

COILS

L101, 201 1-407-878-00 27 mH, microinductor

L301, 401 1-407-519-00 8μH, microinductor

L302, 402 1-407-878-00 27 mH, microinductor

L303, 403 1-407-240-00 22 mH, variable inductor

L304, 404 1-407-878-00 27 mH, microinductor

L305, 405 1-407-269-00 2.2 mH, variable inductor

L306, 406 1-407-267-00 1 mH, variable inductor

L307, 407 1-407-269-00 2.2 mH, variable inductor

CAPACITORS

All capacitors are in μF and electrolytic unless otherwise noted.
50 WV or less are not indicated except for electrolytics.

p = μμF

C101, 201 1-131-191-11 47 6.3 V tantalum

C102, 202 1-107-081-11 68 p silvered mica

C103, 203 1-121-654-11 330 25 V

C104, 204 1-107-131-11 100 p silvered mica

C105, 205 1-131-191-11 47 6.3 V tantalum

C106, 206, 207 1-107-131-11 100 p silvered mica

C108, 208 1-123-044-11 33 25 V

C109, 209 1-107-073-11 33 p silvered mica

C110, 210 1-131-207-11 4.7 25 V tantalum

C111, 211 1-130-072-11 0.022 ±2% 100 V film

⇒ : Due to replacement parts, the descriptions are different on the schematic diagram.

<u>Ref. No.</u>	<u>Part No.</u>	<u>Description</u>	
C306, 406	1-107-085-11	100 p	silvered mica
C307, 407	1-121-413-11	100 6.3 V	
C308, 408	1-121-392-11	3.3 25 V	
C309, 409	1-102-954-11	10 p	ceramic
C310, 410	1-131-215-11	1 35 V	tantalum
C312, 412	1-121-413-11	100 6.3 V	
C313, 413	1-127-379-11	0.68 16 V	solid aluminum
C314, 414	1-121-413-11	100 6.3 V	
C315, 415	1-108-591-12	0.033	mylar
C316, 416	1-131-238-11	10 25 V	tantalum
C317, 417	1-121-426-11	470 16 V	
C318, 418	1-127-024-11	2.2 10 V	solid aluminum
C319, 419	1-121-651-11	10 16 V	
C320, 420	1-130-071-11	0.1 ±2%	100 V film
C321, 421	1-108-565-12	0.0027	mylar
C322, 422	1-107-073-11	33 p	silvered mica
C323, 423	1-108-557-12	0.0012	mylar
C324, 424	1-129-794-11	0.0033 100 V	plastic
C325, 425	1-108-585-12	0.018	mylar
C326, 426	1-130-072-11	0.022 ±2%	100 V film
C327, 427	1-121-726-11	0.47 50 V	
C328, 428	1-121-392-11	3.3 25 V	
C329, 429	1-108-569-12	0.0022	mylar
C330, 430	1-131-215-11	1 35 V	tantalum
C332, 432	1-131-219-11	4.7 35 V	tantalum
C333, 433	1-131-209-11	0.1 35 V	tantalum
C334, 434	1-131-215-11	1 35 V	tantalum
C335, 435	1-107-085-11	100 p	silvered mica
C336, 436	1-131-191-11	47 6.3 V	tantalum
C337, 437	1-107-173-11	150 p	500 V silvered mica
C338, 438	1-131-211-11	0.22 35 V	tantalum
C339, 439	1-107-061-11	10 p	silvered mica
C340, 440	1-121-413-11	100 6.3 V	
C341, 441	1-121-398-11	10 25 V	
C342, 442	1-107-143-11	330 p	silvered mica
C343, 443	1-107-159-11	33 p	silvered mica
C345, 445	1-108-585-12	0.018	mylar
C346, 446	1-108-587-12	0.022	mylar
C347, 447	1-108-585-12	0.018	mylar

<u>Ref. No.</u>	<u>Part No.</u>	<u>Description</u>	
C348, 448	1-108-583-12	0.015	mylar
C501	1-121-416-11	100 25 V	
C502	1-121-414-11	100 10 V	
C503	1-121-398-11	10 25 V	
C504	1-121-404-11	33 25 V	
C505 ~507	1-108-587-12	0.022	mylar
C508	1-121-398-11	10 25 V	
C509	1-121-416-11	100 25 V	
C510	1-107-135-11	150 p	silvered mica
C511	1-121-415-11	100 16 V	
C512	1-121-392-11	3.3 25 V	
C513	1-127-020-11	0.22 10 V	solid aluminum
C514	1-121-419-11	220 6.3 V	
C515	1-121-651-11	10 16 V	
C516	1-101-455-11	0.001	ceramic
C517, 518	1-121-395-11	4.7 25 V	
C519	1-121-651-11	10 16 V	
C601	1-121-651-11	10 16 V	
C602	1-108-240-12	0.015	mylar
C603	1-129-899-11	0.056 ±2%	100 V plastic
C604	1-108-912-11	0.015	mylar
C605	1-121-651-11	10 16 V	
C606	1-131-215-11	1 35 V	tantalum
C607	1-131-211-11	0.22 35 V	tantalum
C608	1-131-217-11	2.2 35 V	tantalum
C609	1-121-409-11	47 16 V	
C610, 611	1-161-130-11	1000 p	ceramic (boundary layer)
C701	1-123-070-11	2200 16 V	
C702, 703	1-123-067-11	2200 25 V	
C704, 705	1-123-061-11	1000 50 V	
C706	1-121-261-11	220 35 V	
C707, 708	1-121-415-11	100 16 V	
C709	1-121-416-11	100 25 V	
C710, 711	1-161-130-11	0.001	ceramic (boundary layer)
C712	1-121-450-11	2.2 50 V	
C713	1-121-395-11	4.7 25 V	
C714	1-121-968-11	10 16 V	
C715	1-121-450-11	2.2 50 V	

Note: The components identified by shading are critical for safety. Replace only with part number specified.

Ref. No.	Part No.	Description	
C716, 717	1-121-726-11	0.47	50 V
C718	1-121-395-11	4.7	25 V
C719	1-108-389-12	0.1	100 V mylar
C720	1-121-450-11	2.2	50 V
C721	1-121-257-11	4.7	16 V
C722	1-108-251-12	0.1	mylar
C723	1-121-395-11	4.7	25 V
C724~727	1-161-136-11	0.01	ceramic (boundary layer)
C728	1-161-140-11	0.047	ceramic (boundary layer)
C729	1-121-415-11	100	16 V
C730	1-131-191-11	47	6.3 V tantalum
C731	1-121-651-11	10	16 V
C732, 733	1-121-479-11	22	16 V
C734	1-161-140-11	0.047	ceramic (boundary layer)
C736	1-121-352-11	47	10 V
CT344, 444	1-141-010-XX	Trimmer	

RESISTORS

All resistors are in ohms. Common ¼ W carbon resistors are omitted. Check schematic diagram for values. k = 1000

R130, 230	1-210-850-11	300	±2% ¼ W carbon
R158, 258	1-244-857-11	220	½ W carbon

R701	1-217-371-11	0.47	¼ W fusible
R702	1-217-375-11	1	¼ W fusible
R706	1-217-465-11	0.47	1 W fusible
R707	1-217-485-11	22	1 W fusible
R713	1-244-873-11	1k	½ W carbon
R719	1-244-865-11	470	½ W carbon
R720	1-217-375-11	1	¼ W fusible
R721	1-206-511-11	10	3 W metal-oxide (nonflammable)
R722	1-244-881-11	2.2 k	½ W carbon
R755, 757	1-244-869-11	680	½ W carbon
R765	1-244-873-11	1 k	½ W carbon

Ref. No.	Part No.	Description	
R773	1-217-465-11	0.47	1 W fusible
R787	1-206-527-11	47	3 W metal-oxide (nonflammable)
R792	1-206-520-11	24	3 W metal-oxide (nonflammable)
RV101, 201	1-224-250-XX	2.2 k adjustable	
RV102, 202	1-224-251-XX	4.7 k adjustable	
RV103, 203	1-224-550-21	220 adjustable	
RV104, 204	1-224-821-00	20 k variable, LINE OUT LEVEL ADJUST	
RV105, 205	1-224-251-XX	4.7 k adjustable	
RV106, 206	1-224-333-00	10 k variable, FM CAL	
RV301, 401	1-224-561-00	20 k variable, REC LEVEL-MIC	
RV302, 402	1-224-736-00	50 k variable, REC LEVEL-LINE	
RV303, 403	1-224-823-00	20 k variable, REC MASTER- PRESET/VOLUME	
RV305, 405	1-224-644-XX	4.7 k adjustable	
RV306, 406	1-224-756-00	20 k variable, CAL	
RV307, 407	1-224-822-00	20 k variable, PHONES LEVEL	
RV501	1-224-646-XX	22 k adjustable	
RV601	1-224-493-00	10 k adjustable	
RV701, 702	1-224-251-XX	4.7 k adjustable	
RV703, 704	1-224-250-XX	2.2 k adjustable	
RV705	1-224-253-XX	22 k adjustable	

SWITCHES

S1	1-516-685-00	Lever Slide, MONITOR
S2	1-552-025-00	Rotary Slide, DOLBY NR
S3	1-516-365-00	Rotary Slide, MIC ATT
S4	1-516-685-00	Lever Slide, MPX FILTER
S5, 6	1-516-482-00	Lever Slide, EQ, BIAS
S7	1-516-693-00	Pushbutton, POWER
S9, 10	1-516-974-00	Slide, TIMER, MEMORY
S11	—	Included in tape counter
S12	1-516-028-XX	Micro, erasure-proof
S19	1-516-383-00	Micro, cassette detecting

JACKS

CN11, 2	1-526-528-00	AC OUTLET
---------	--------------	-----------

Note: The components identified by shading are critical for safety. Replace only with part number specified.

<u>Ref. No.</u>	<u>Part No.</u>	<u>Description</u>
CNJ3	1-507-255-00	Connector, 11-p; REMOTE CONTROL
CNJ101, 201 CNJ301, 401	1-507-433-00	Phono, 4-p; LINE OUT, LINE IN
CNJ302, 402	1-507-455-00	MIC
CNJ501	1-507-507-00	HEADPHONES
CNJ502	1-507-453-00	LINE IN (STEREO)

SOLENOIDS

PM1	1-454-145-00	Tape Pull-out
PM2	1-454-144-00	Pinch Roller Drive
PM3	1-454-156-00	Eject
PM4	1-454-130-00	Brake

MISCELLANEOUS

CPI	1-231-057-31	Encapsulated Component
-----	--------------	------------------------

<u>Ref. No.</u>	<u>Part No.</u>	<u>Description</u>
CP501	1-464-061-00	Unit, bias osc
EH501	8-825-676-00	Head, erase; EF172-65
M1	8-835-003-00	Motor, capstan; DNF-1400A
M2, 3	8-835-005-00	Motor, reel; MNR-1500R
ME101, 201	1-520-258-00	Meter, VU; including PL2, 3
PH501	8-825-674-00	Head, playback; PF169-6502
PL1	1-518-145-XX	Lamp, 5 V 60 mA
PL2, 3	1-518-273-00	Lamp, 6.3 V 70 mA; meter
PL4~13	1-518-115-XX	Lamp, 6 V 35 mA
RH501	8-825-673-00	Head, record; RF169-6502
RY1	1-515-267-00	Relay
T1	1-442-740-00	Transformer, power
	1-536-401-XX	Terminal Strip
	1-534-986-XX	Cord, power

ACCESSORIES & PACKING MATERIALS

<u>Part No.</u>	<u>Description</u>
X-3549-745-0	Cushion Ass'y, upper
X-3701-018-3	Tips Ass'y, head cleaning (Canadian model)
1-534-049-31	Cord, connection; RK-74H
3-548-770-00	Spacer, cassette lid
3-548-780-00	Cushion, lower (front) (US model)
3-548-781-00	Cushion, lower (back) (US model)
3-548-788-00	Cushion, lower (front) (Canadian model)
3-548-789-00	Cushion, lower (back) (Canadian model)
3-548-796-00	Carton (US model)
3-548-797-00	Carton (Canadian model)
3-429-126-00	Bag, plastic; set (US model)
3-701-985-00	Tape Driver
3-780-963-21	Manual, instruction (US model)
3-780-963-31	Manual, instruction
3-794-040-31	Manual, instruction; French } (Canadian model)
4-837-003-00	Bag, plastic; set (Canadian model)
8-893-508-10	Tape, demonstration

Note: The components identified by shading are critical for safety. Replace only with part number specified.

ELCASET**DOLBY FM****STEREO ELCASET DECK****EL-7***US Model*

No 3

November, 1977

SUPPLEMENT

This supplement updates the service manual for US model to include production changes.

File this supplement with the service manual of part number 9-954-455-21.

1. IDENTIFICATION OF SET

Former model

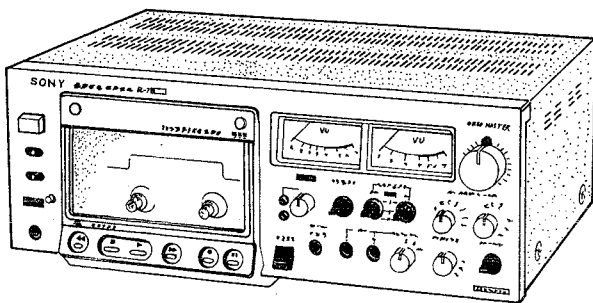

(Without Side Boards)

New model

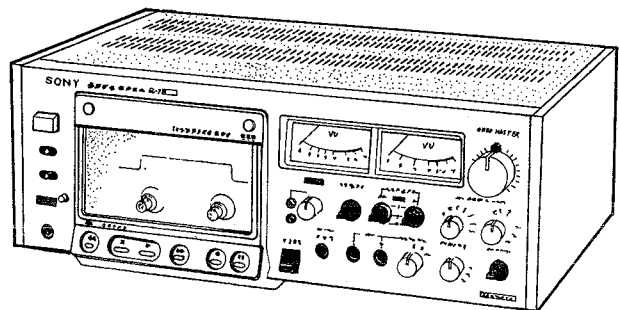

(With Side Boards)

2. SPECIFICATION CHANGES

Dimensions: Approx
460(w) x 170(h) x 320(d) mm
18¹/₈(w) x 6³/₄(h) x 12⁵/₈(d) inches
including projecting parts and controls

Weight: Approx 13.5 kg (29 lbs 13 oz)

Note: Refer to the service manual for other specifications.

SAFETY-RELATED COMPONENT WARNING!!

COMPONENTS IDENTIFIED BY SHADING AND  MARK ON THE SCHEMATIC DIAGRAMS, EXPLODED VIEWS AND IN THE PARTS LIST ARE CRITICAL TO SAFE OPERATION. REPLACE THESE COMPONENTS WITH SONY PARTS WHOSE PART NUMBERS APPEAR AS SHOWN IN THIS MANUAL OR IN SUPPLEMENTS PUBLISHED BY SONY.

SONY
SERVICE MANUAL

3. MECHANICAL ADJUSTMENTS

 : changed portion

Note: Refer to the service manual for other adjustments.

Solenoid Position Adjustment

1. Loosen the screw A and push the pinch roller solenoid in the direction shown by the arrow (A)
2. In playback and pause mode, loosen the screw B and adjust the tape pull-out solenoid position to obtain the clearance (B)

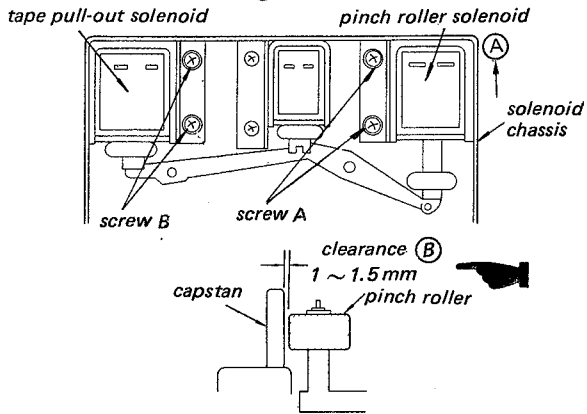

3. In playback mode, adjust the pinch roller solenoid position to obtain the clearance (C)

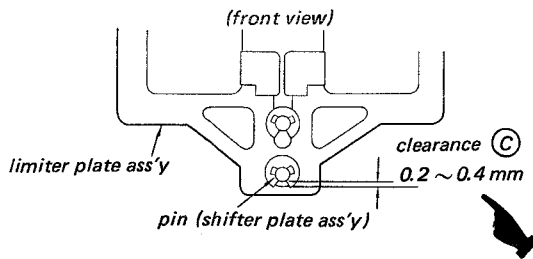

Torque Adjustment

1. Back Tension Torque -- Playback mode --

Torque meter	Meter reading
CQ-101L	50 - 55 g·cm (0.7 - 0.76 oz·inch)

If necessary, adjust RV703.

2. Forward Torque -- Playback mode --

Torque meter	Meter reading
CQ-101L	115 - 125 g·cm (1.6 - 1.7 oz·inch)

If necessary, adjust RV704.

3. Fast Forward Rewind Torque

Torque meter	Meter reading
CQ-201L	300 - 400 g·cm (4.2 - 5.5 oz·inch)

4. In fast forward mode, make sure that the supply reel spindle stops while lightly holding it.
5. In rewind mode, make sure that the take-up reel spindle stops while lightly holding it.

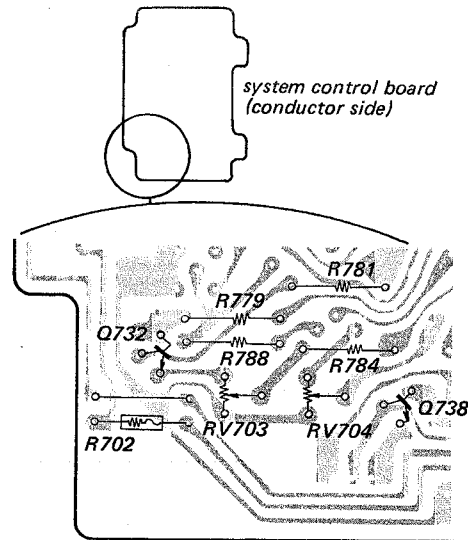

These adjustments are printed on page 23 of the service manual.

Note: Refer to the service manual for other adjustments.

 : changed portion

4. ELECTRICAL ADJUSTMENTS

Note: The adjustments should be performed in the order given in this service manual.

The adjustments should be performed for both L-CH and R-CH.

Switches and controls should be set as follows unless otherwise specified.

- POWER switch: ON
- TIMER switch: OFF
- MEMORY switch: OFF
- DOLBY NR switch: OFF
- MPX FILTER switch: OFF
- TAPE SELECT EQ switch: TYPE I
- TAPE SELECT BIAS switch: TYPE I
- MIC ATT switch: 0
- PHONES LEVEL control: 0
- REC LEVEL-MIC control: 0
- REC LEVEL-LINE control: 0
- MONITOR switch: TAPE
- REC MASTER control: MAX
- LEVEL ADJUST control: fully clockwise (on the rear panel)

BIAS and EQ switch settings in accordance with tape used are as follows.

Test Tape	EQ switch	BIAS switch
CS-60 (SLH)	TYPE I	TYPE I
CS-70 (DUAD)	TYPE II	TYPE II

Standard Record

Set the REC LEVEL-LINE control for the specified output level. (REC LEVEL-MIC control: 0 position)

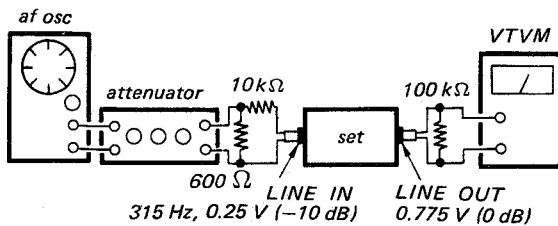

Standard Input Level

	MIC	LINE IN
source impedance	300Ω	10 kΩ
input level	0.77 mV (-60dB)	0.25 V (-10dB)

Standard Output Level

	LINE OUT	HEADPHONES
load impedance	100 kΩ	8Ω
output level	0.775 V (0 dB)	0.038 V (-28 dB)

Monitor Level Adjustment

Setting:

MONITOR switch:

SOURCE

Procedure:

- Mode: record

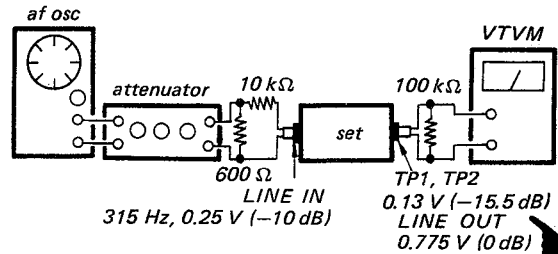

- Adjust REC LEVEL-LINE control (RV302, 402) for 0.13 V (-15.5 dB) at TP1 or TP2.
- Adjust RV305 (L-CH) and RV405 (R-CH) for 0.775 V (0 dB) at the L-CH and R-CH LINE OUT.

Specification:

Level difference between channels:
less than 0.5 dB

Adjustment Location:

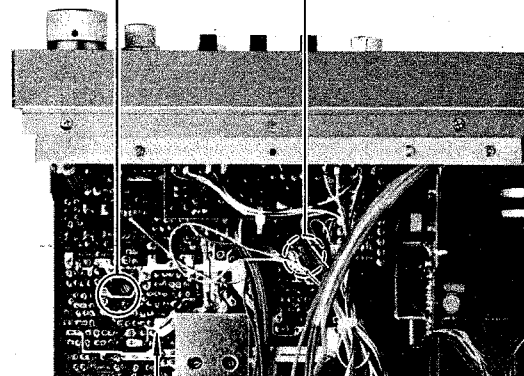
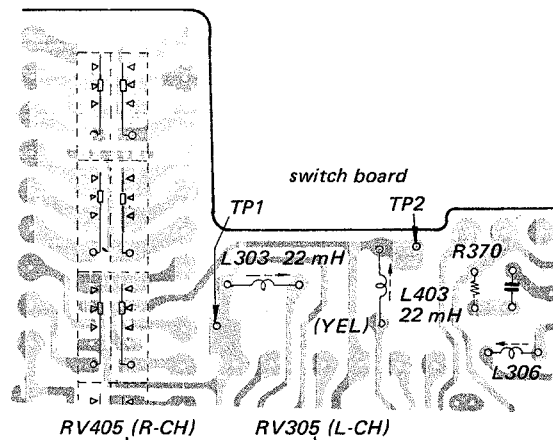

This adjustment is printed on page 24 of the service manual.

5. REPLACEMENT SEMICONDUCTORS

Replacement Semiconductors

For replacement, use semiconductors except in ().

IC101, 201, 301, 401: CX064

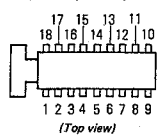

IC102, 202: TA7066P

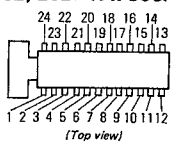

IC601: CX065A (CX065)

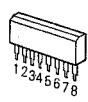

IC701: CX738A

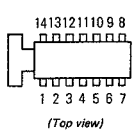

Q101, 201: 2SK43

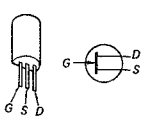

Q102, 103, 109, 111
Q202, 203, 209, 211
Q301, 302, 308
Q401, 402, 408 } : 2SC632A

Q104 ~ 108, 112
Q204 ~ 208, 212
Q303 ~ 307, 403 ~ 407
Q309, 409, 501, 503 ~ 505
Q509 } : 2SC634A

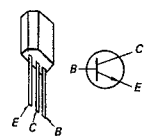

Q110, 210: 2SC1474
Q502: 2SC1475

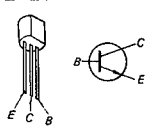

Q506: 2SA678 (2SA677)

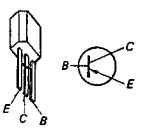

Q601, 602, 701, 703, 704
Q706 ~ 708, 710 ~ 712
Q714 ~ 716, 718 ~ 720
Q722, 724, 725, 727
Q729 ~ 733, 735, 737
Q738, 740 ~ 744, 746 } : 2SC634A

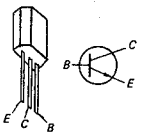

(2SC1364)

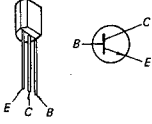

Q603, 702, 728
Q736, 739 } : 2SC1173
Q705, 709, 721: 2SC1061

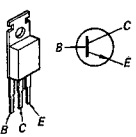

Q713, 717: 2SC1475 (2SC1318)
Q734: 2SC1475 (2SC1383)

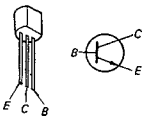

Q723, 726: 2SC1124

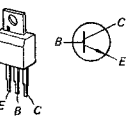

Q745: TSP603

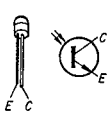

D101, 102
D201, 202
D602, 716
D726, 735 } : 1T22A (1T22)

D501, 503
D505 ~ 508
D601, 712 ~ 715
D717, 718, 723
D724, 727, 729
D733, 736 ~ 743 } : 1S1555 (1T40)

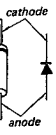

D701, 702
D704 ~ 709
D719 ~ 722
D725, 731
D734 } : 10E2

(S1B01-02)

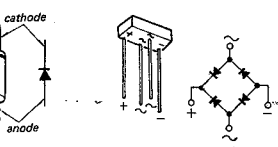

D502: EQB01-21 (EQA01-21R)
D504: EQB01-05 (EQA01-05R)
D703: EQB01-06 (EQA01-06S)
D710: EQB01-12Z (EQA01-12)
D711: EQB01-10 (EQA01-10)
D730, 732: EQB01-22 (EQA01-22R)
D744: EQB01-07 (EQA01-07S)

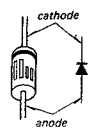

D603: KB369

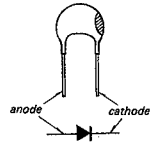

D728: MV203

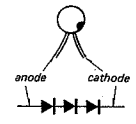

8. MOUNTING DIAGRAM
- Conductor Side -

D	Q, IC
705	705 702
709	704 708
710 711	701 706
703	703
728	745
707	707
708	712
710	710
707 706	738
743	743
713	744 741
705	742
704	740
702 737	718
701 735	729 728
739	724 719
741	720
713	721
725	723
740	727
716	722 720
721	727
717	724 715
727	718
719	726
721	717
722 720	725
724 715	716
718	730 733
723	731 734
714 729	737
733	732
743	731 714
726	732
742	738 735
716	739 736
730	736
731	
712	

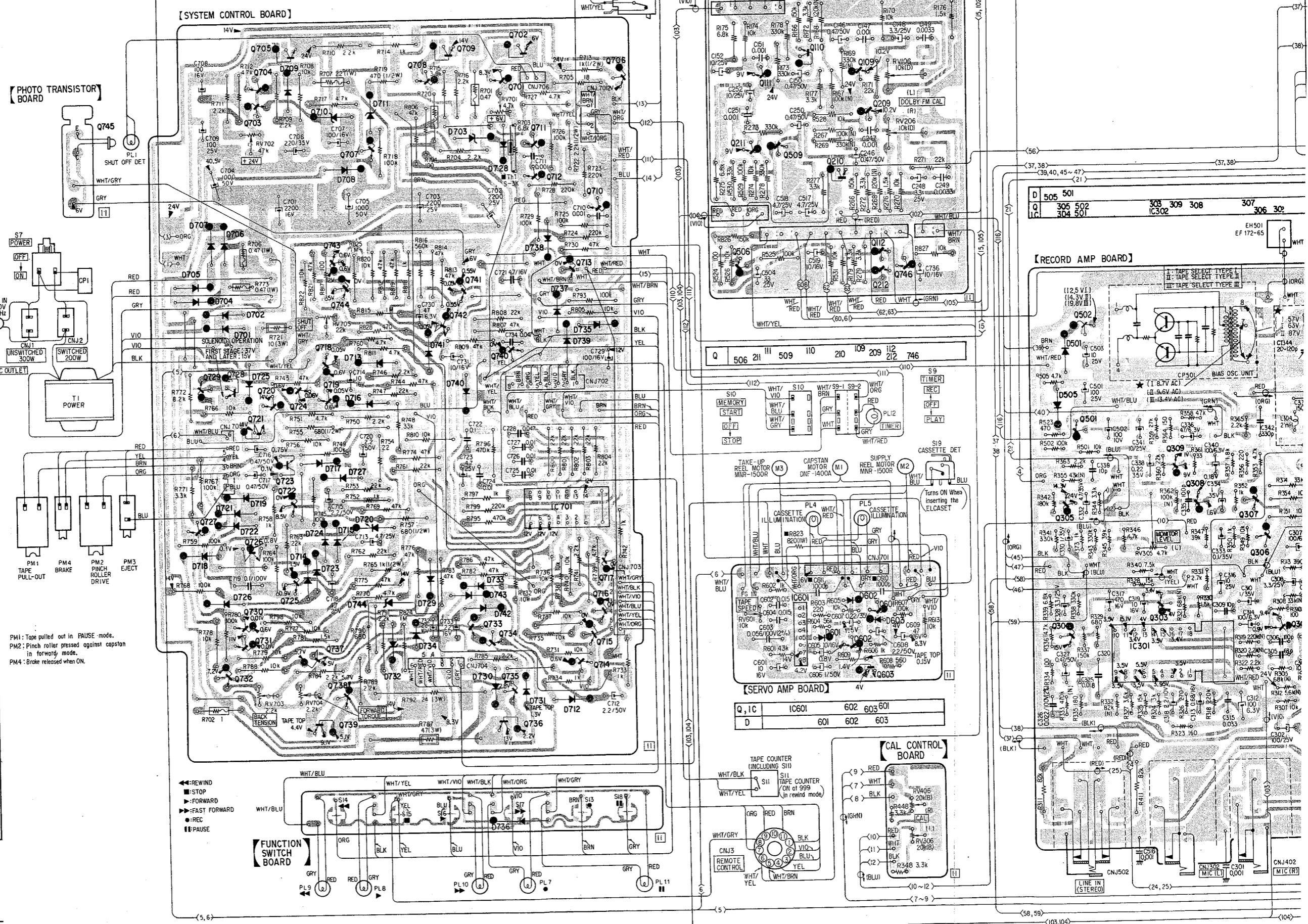

D	Q, IC
505	501
305	502
304	501
308	IC302
309	
308	
307	
306	
302	

Q, IC	IC601	602	603	601
D	601	602	603	

[JACK BOARD]

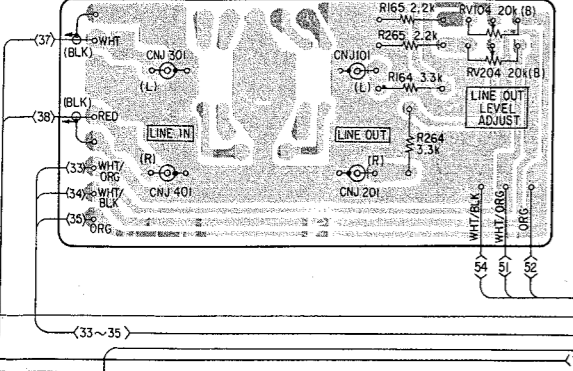

IC202	IC102	504	107	IC101	106, 105	104	108	103	102	101	Q
202	201	207	505	IC201	205, 206	204	208	203	202	201	IC
											D

[PLAYBACK AMP BOARD]

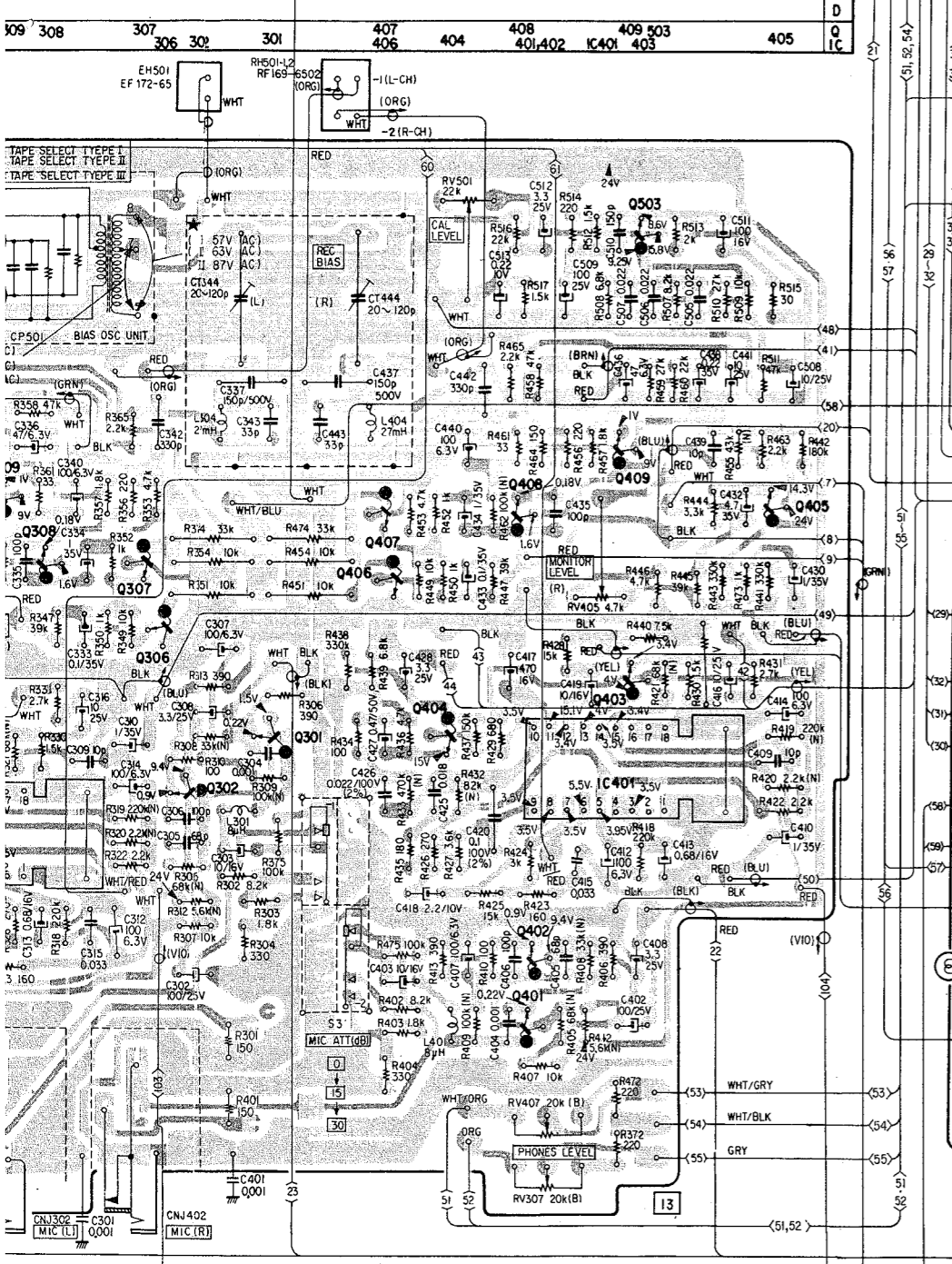
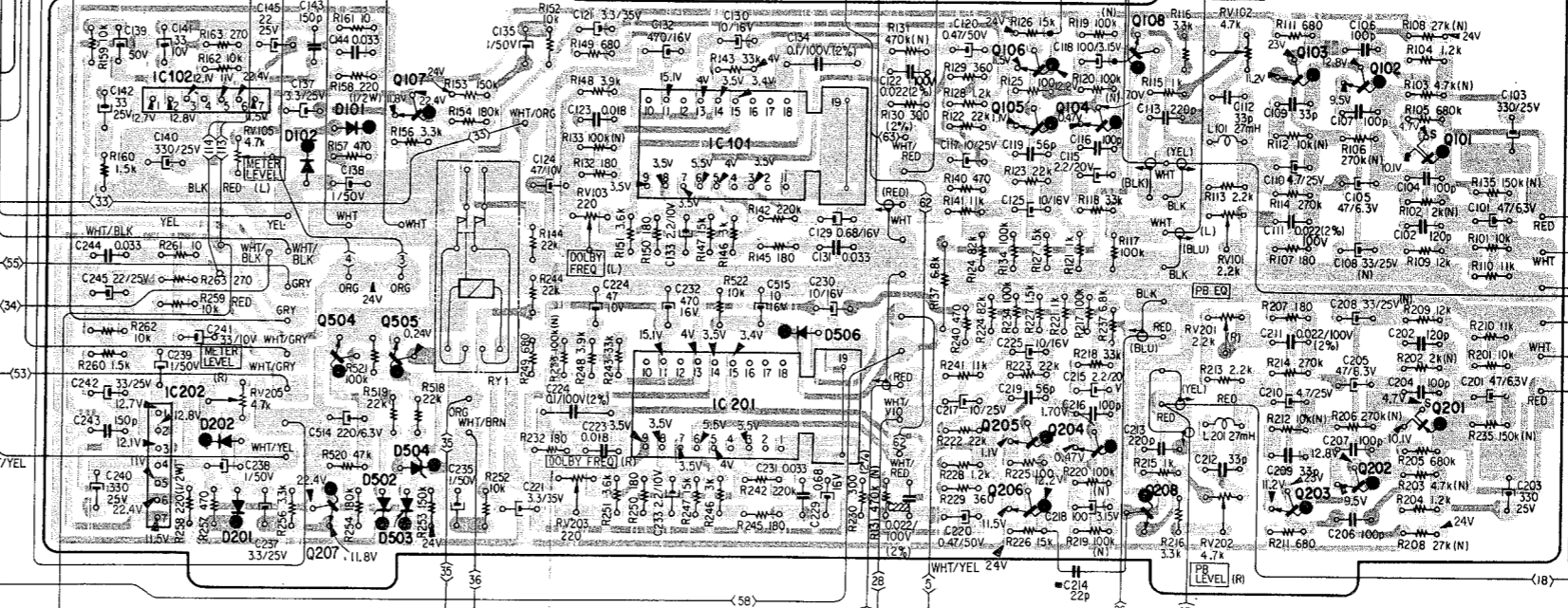

[SWITCH BOARD]

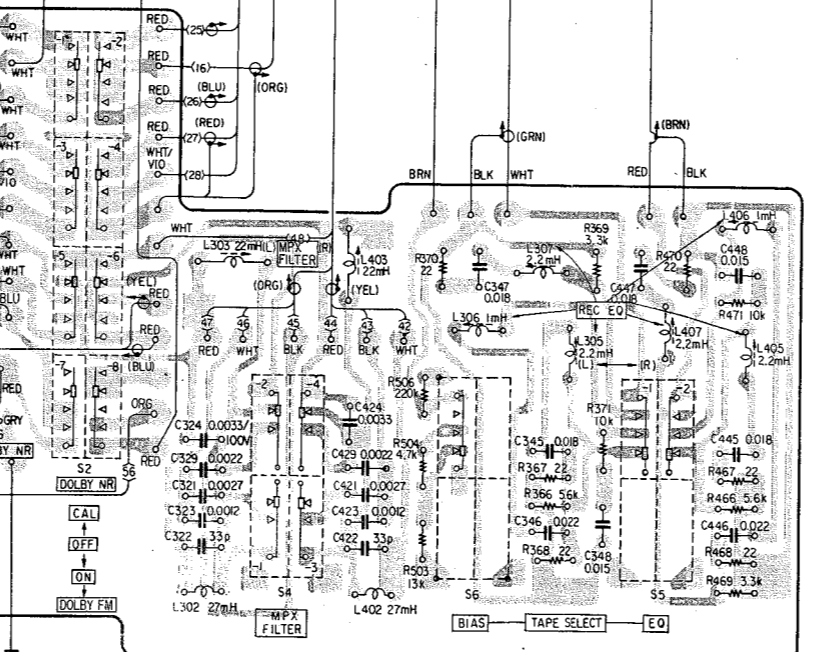

[MASTER CONTROL BOARD]

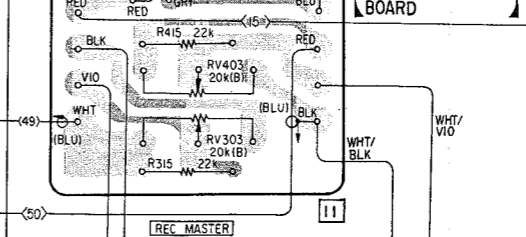

[MONITOR SWITCH BOARD]

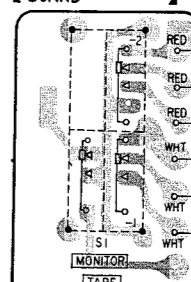

[RECORD LEVEL CONTROL BOARD]

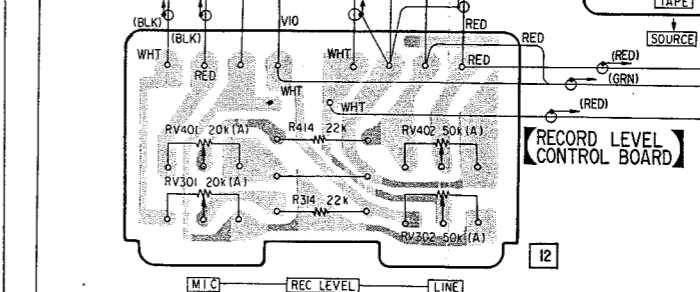

A B C D E

(3)

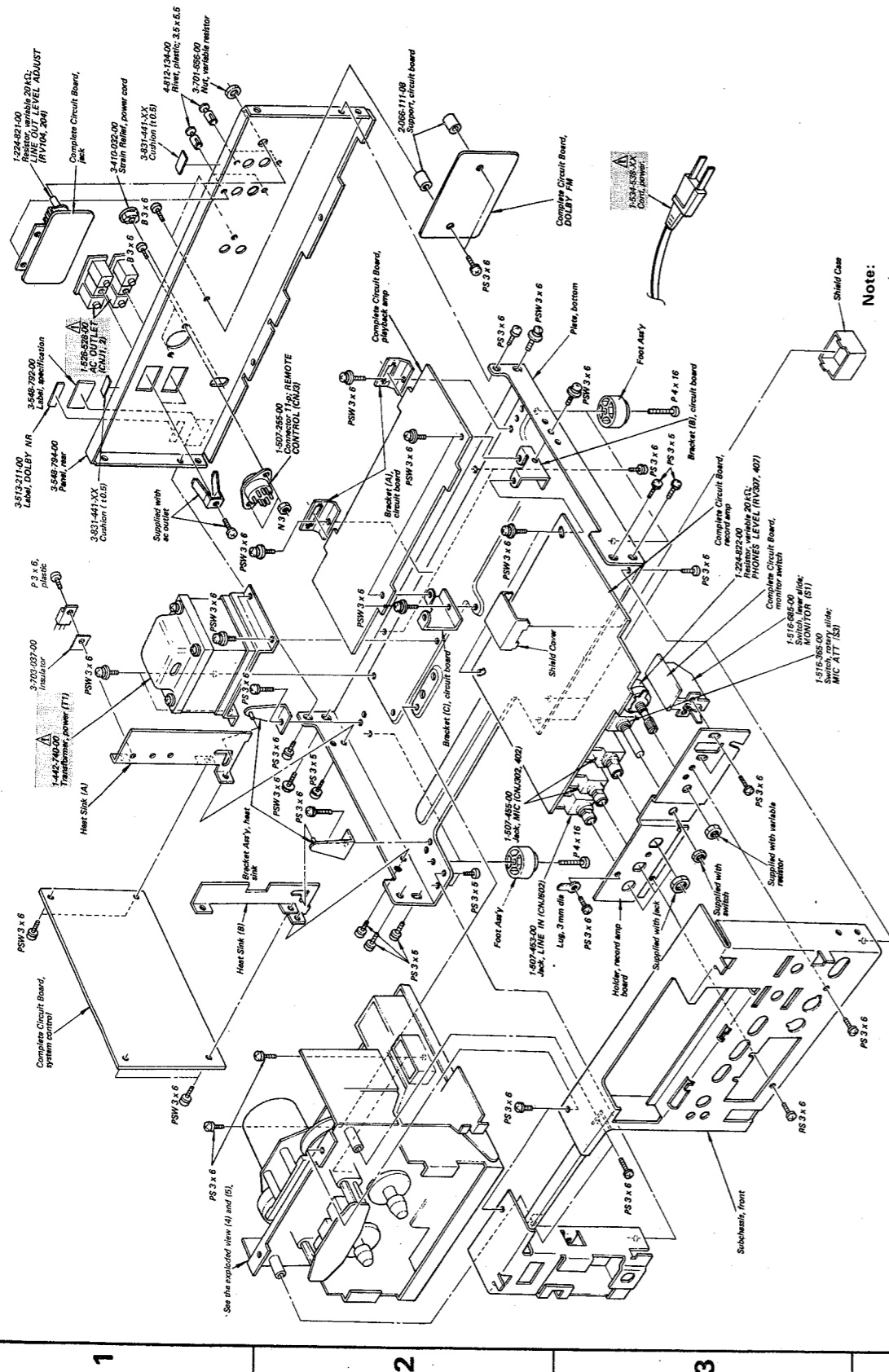

Note:

- Items with no part number and/or no description are not stocked because they are seldom required for routine service.
- All screws are Phillips (cross recess) type unless otherwise noted.
- (-) = slotted head

Note: The components identified by shading and Δ mark are critical for safety. Replace only with part number specified.

A B C D E

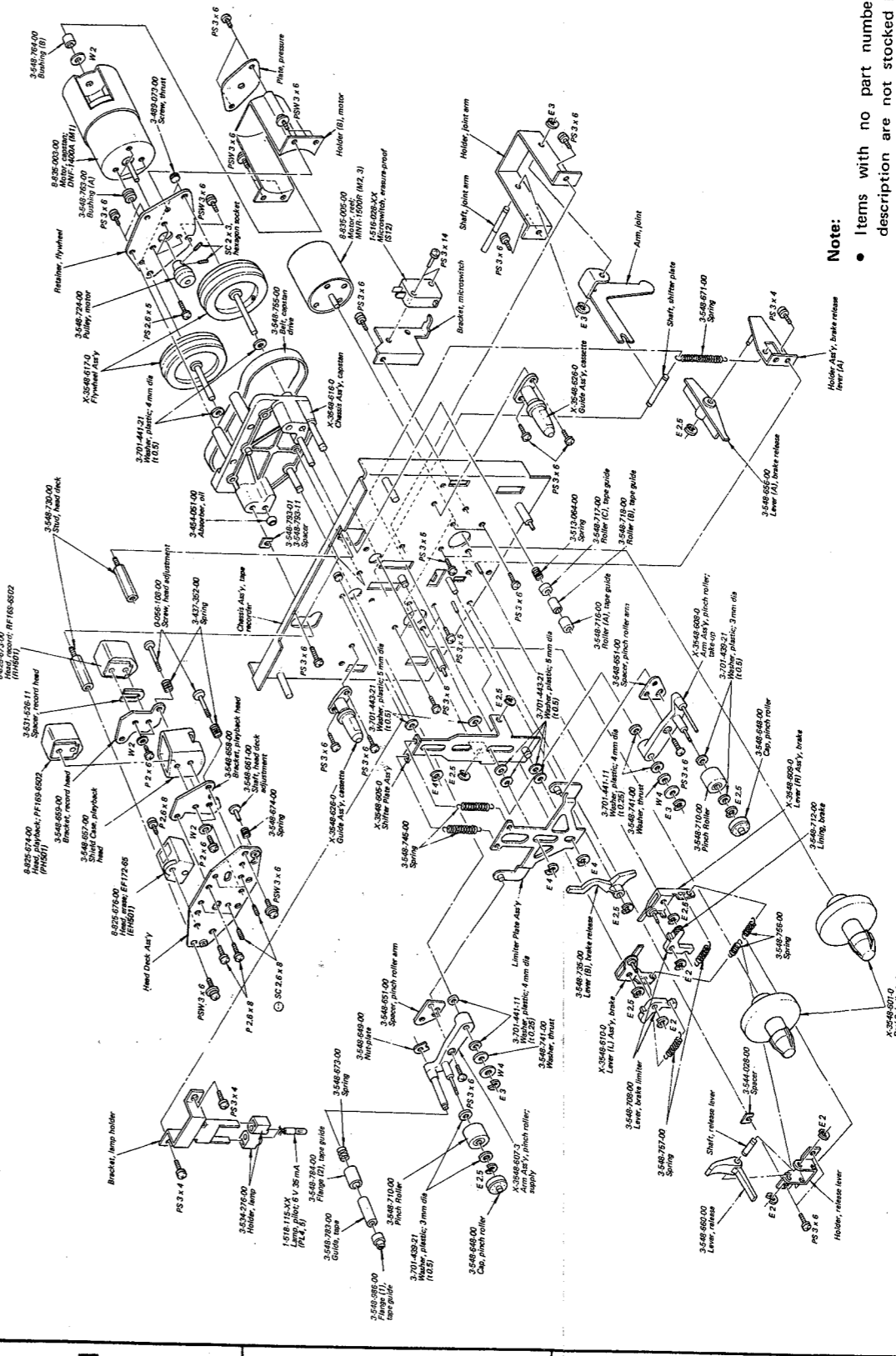

(4)



Note:

- Items with no part number and/or no description are not stocked because they are seldom required for routine service.
- All screws are Phillips (cross recess) type unless otherwise noted.
- (-) = slotted head

10. ELECTRICAL PARTS LIST

<u>Ref. No.</u>	<u>Part No.</u>	<u>Description</u>	<u>Ref. No.</u>	<u>Part No.</u>	<u>Description</u>
SEMICONDUCTORS					
Transistors					
Q101, 201		2SK43	⇒Q735		2SC634A
Q102, 202		2SC632A	Q736		2SC1173
Q103, 203			⇒Q737, 738		2SC634A
Q104~108		2SC634A	Q739		2SC1173
Q204~208			⇒Q740~744		2SC634A
Q109, 209		2SC632A	Q745		TPS603
Q110, 210		2SC1474	⇒Q746		2SC634A
Q111, 211		2SC632A	ICs		
Q112, 212		2SC634A	IC101, 201		CX064
Q301, 401		2SC632A	IC102, 202		TA7066P
Q302, 402			IC301, 401		CX064
Q303~307		2SC634A	⇒IC601		CX065A
Q403~407			IC701		CX738
Q308, 408		2SC632A	Diodes		
Q309, 409		2SC634A	⇒D101, 201		1T22A
Q501		2SC634A	⇒D102, 202		
Q502		2SC1475	⇒D501		1S1555
Q503~505		2SC634A	⇒D502		EQB01-21
⇒Q506		2SA678	⇒D503		1S1555
⇒Q509		2SC634A	⇒D504		EQB01-05
⇒Q601, 602		2SC634A	⇒D505~508		1S1555
Q603		2SC1173	⇒D601		1S1555
⇒Q701		2SC634A	⇒D602		1T22A
Q702		2SC1173	D603		KB369
⇒Q703, 704		2SC634A	⇒D701, 702 		10E2
Q705		2SC1061	⇒D703		EQB01-06
⇒Q706~708		2SC634A	⇒D704~707 		10E2
Q709		2SC1061	⇒D708, 709		10E2
⇒Q710~712		2SC634A	⇒D710		EQB01-12Z
⇒Q713		2SC1475	⇒D711		EQB01-10
⇒Q714~716		2SC634A	⇒D712~715		1S1555
⇒Q717		2SC1475	⇒D716		1T22A
⇒Q718~720		2SC634A	⇒D717, 718		1S1555
Q721		2SC1061	⇒D719~722		10E2
⇒Q722		2SC634A	⇒D723, 724		1S1555
Q723		2SC1124	⇒ Due to replacement parts, the descriptions are offere nt on the schematic diagram.		
⇒Q724, 725		2SC634A	Note: The components identified by shading and  mark are critical for safety. Replace only with part number specified.		
Q726		2SC1124			
⇒Q727		2SC634A			
Q728		2SC1173			
⇒Q729~733		2SC634A			
⇒Q734		2SC1475			

<u>Ref. No.</u>	<u>Part No.</u>	<u>Description</u>
⇒ D725		10E2
⇒ D726		1T22A
⇒ D727		1S1555
D728		MV 203V
⇒ D729		1S1555
⇒ D730		EQB01-22
⇒ D731		10E2
⇒ D732		EQB01-22
⇒ D733		1S1555
⇒ D734		10E2
⇒ D735		1T22A
⇒ D736 ~ 743		1S1555
⇒ D744		EQB01-07
Thermistor		
Th1	1-800-200-00	S-3K
COILS		
L101, 201	1-407-878-00	27 mH, microinductor
L301, 401	1-407-519-00	8μH, microinductor
L302, 402	1-407-878-00	27 mH, microinductor
L303, 403	1-407-240-00	22 mH, variable inductor
L304, 404	1-407-878-00	27 mH, microinductor
L305, 405	1-407-269-00	2.2 mH, variable inductor
L306, 406	1-407-267-00	1 mH, variable inductor
L307, 407	1-407-269-00	2.2 mH, variable inductor
CAPACITORS		
All capacitors are in μF and electrolytic unless otherwise noted. 50 WV or less are not indicated except for electrolytics. p = μμF		
C101, 201	1-131-191-11	47 6.3 V tantalum
C102, 202	1-107-087-11	120 p silvered mica
C103, 203	1-121-654-11	330 25 V
C104, 204	1-107-131-11	100 p silvered mica
C105, 205	1-131-191-11	47 6.3 V tantalum
C106, 206, C107, 207	1-107-131-11	100 p silvered mica
C108, 208	1-123-044-11	33 25 V
C109, 209	1-107-073-11	33 p silvered mica
C110, 210	1-131-207-11	4.7 25 V tantalum
C111, 211	1-130-072-11	0.022 ±2% 100 V film

⇒ : Due to replacement parts, the descriptions are different on the schematic diagram.

<u>Ref. No.</u>	<u>Part No.</u>	<u>Description</u>
C112, 212	1-107-073-11	33 p silvered mica
C113, 213	1-107-093-11	220 p silvered mica
C114, 214	1-102-967-11	22 p ceramic
C115, 215	1-131-196-11	2.2 20 V tantalum
C116, 216	1-107-131-11	100 p silvered mica
C117, 217	1-121-398-11	10 25 V
C118, 218	1-131-187-11	100 3.15 V tantalum
C119, 219	1-107-079-11	56 p silvered mica
C120, 220	1-121-726-11	0.47 50 V
C121, 221	1-131-218-11	3.3 35 V tantalum
C122, 222	1-130-072-11	0.022 ±2% 100 V film
C123, 223	1-108-585-12	0.018 mylar
C124, 224	1-121-352-11	47 10 V
C125, 225	1-121-651-11	10 16 V
C129, 229	1-127-379-11	0.68 16 V solid aluminum
C130, 230	1-121-651-11	10 16 V
C131, 231	1-108-591-12	0.033 mylar
C132, 232	1-121-426-11	470 16 V
C133, 233	1-127-024-11	2.2 10 V solid aluminum
C134, 234	1-130-071-11	0.1 ±2% 100 V film
C135, 235	1-121-391-11	1 50 V
C137, 237	1-121-392-11	3.3 25 V
C138, 238, C139, 239	1-121-391-11	1 50 V
C140, 240	1-121-654-11	330 25 V
C141, 241	1-121-402-11	33 10 V
C142, 242	1-121-404-11	33 25 V
C143, 243	1-107-135-00	150 p silvered mica
C144, 244	1-108-591-12	0.033 mylar /
C145, 245	1-121-480-11	22 25 V
C146, 246	1-121-726-11	0.47 50 V
C147, 247	1-108-227-12	0.001 mylar
C148, 248	1-121-392-11	3.3 25 V
C149, 249	1-108-567-12	0.0033 mylar
C150, 250	1-121-911-11	0.47 50 V
C151, 251	1-108-227-12	0.001 mylar
C152, 252	1-121-748-11	10 25 V
C301, 401	1-101-455-11	0.001 ceramic
C302, 402	1-121-416-11	100 25 V
C303, 403	1-121-916-11	10 16 V
C304, 404	1-108-227-12	0.001 mylar
C305, 405	1-107-081-11	68 p silvered mica

<u>Ref. No.</u>	<u>Part No.</u>	<u>Description</u>		<u>Ref. No.</u>	<u>Part No.</u>	<u>Description</u>	
C306, 406	1-107-085-11	100 p	silvered mica	C348, 448	1-108-583-12	0.015	mylar
C307, 407	1-121-413-11	100	6.3 V	C501	1-121-416-11	100	25 V
C308, 408	1-121-392-11	3.3	25 V	C502	1-121-414-11	100	10 V
C309, 409	1-102-954-11	10 p	ceramic	C503	1-121-398-11	10	25 V
C310, 410	1-131-215-11	1	35 V tantalum	C504	1-121-404-11	33	25 V
C312, 412	1-121-413-11	100	6.3 V	C505 ~ 507	1-108-587-12	0.022	mylar
C313, 413	1-127-379-11	0.68	16 V solid aluminum	C508	1-121-398-11	10	25 V
C314, 414	1-121-413-11	100	6.3 V	C509	1-121-416-11	100	25 V
C315, 415	1-108-591-12	0.033	mylar	C510	1-107-135-11	150 p	silvered mica
C316, 416	1-131-238-11	10	25 V tantalum	C511	1-121-415-11	100	16 V
C317, 417	1-121-426-11	470	16 V	C512	1-121-392-11	3.3	25 V
C318, 418	1-127-024-11	2.2	10 V solid aluminum	C513	1-127-020-11	0.22	10 V solid aluminum
C319, 419	1-121-651-11	10	16 V	C514	1-121-419-11	220	6.3 V
C320, 420	1-130-071-11	0.1	±2% 100 V film	C515	1-121-651-11	10	16 V
C321, 421	1-108-565-12	0.0027	mylar	C516	1-101-455-11	0.001	ceramic
C322, 422	1-107-073-11	33 p	silvered mica	C517, 518	1-121-395-11	4.7	25 V
C323, 423	1-108-557-12	0.0012	mylar	C519	1-121-651-11	10	16 V
C324, 424	1-108-232-12	0.0033	mylar	C601	1-121-651-11	10	16 V
C325, 425	1-108-585-12	0.018	mylar	C602	1-108-240-12	0.015	mylar
C326, 426	1-130-072-11	0.022	±2% 100 V film	C603	1-129-899-11	0.056	±2% 100 V plastic
C327, 427	1-121-726-11	0.47	50 V	C604	1-108-912-11	0.015	mylar
C328, 428	1-121-392-11	3.3	25 V	C605	1-121-651-11	10	16 V
C329, 429	1-108-569-12	0.0022	mylar	C606	1-121-952-11	1	50 V
C330, 430	1-131-215-11	1	35 V tantalum	C607	1-131-211-11	0.22	35 V tantalum
C332, 432	1-131-219-11	4.7	35 V tantalum	C608	1-121-986-11	2.2	50 V
C333, 433	1-131-209-11	0.1	35 V tantalum	C609	1-121-409-11	47	16 V
C334, 434	1-131-215-11	1	35 V tantalum	C610, 611	1-161-130-11	1000 p	ceramic (boundary layer)
C335, 435	1-107-085-11	100 p	silvered mica	C701	△ 1-123-070-11	2200	16 V
C336, 436	1-131-191-11	47	6.3 V tantalum	C702, 703	△ 1-123-067-11	2200	25 V
C337, 437	1-107-173-11	150 p	500 V silvered mica	C704, 705	△ 1-123-061-11	1000	50 V
C338, 438	1-131-211-11	0.22	35 V tantalum	C706	1-121-261-11	220	35 V
C339, 439	1-107-061-11	10 p	silvered mica	C707, 708	1-121-415-11	100	16 V
C340, 440	1-121-413-11	100	6.3 V	C709	1-121-416-11	100	25 V
C341, 441	1-121-398-11	10	25 V	C710, 711	1-161-130-11	0.001	ceramic (boundary layer)
C342, 442	1-107-143-11	330 p	silvered mica	C712	1-121-450-11	2.2	50 V
C343, 443	1-107-159-11	33 p	silvered mica	C713	1-121-395-11	4.7	25 V
C345, 445	1-108-585-12	0.018	mylar	C714	1-121-968-11	10	16 V
C346, 446	1-108-587-12	0.022	mylar	C715	1-121-450-11	2.2	50 V
C347, 447	1-108-585-12	0.018	mylar				

Note: The components identified by shading and △ mark are critical for safety. Replace only with part number specified.

Ref. No.	Part No.	Description	
C716, 717	1-121-726-11	0.47	50 V
C718	1-121-395-11	4.7	25 V
C719	1-108-389-12	0.1	100 V mylar
C720	1-121-450-11	2.2	50 V
C721	1-121-257-11	4.7	16 V
C722	1-108-251-12	0.1	mylar
C723	1-121-395-11	4.7	25 V
C724 ~ 727	1-161-136-11	0.01	ceramic (boundary layer)
C728	1-161-140-11	0.047	ceramic (boundary layer)
C729	1-121-415-11	100	16 V
C730	1-131-191-11	47	6.3 V tantalum
C731	1-121-651-11	10	16 V
C732, 733	1-121-479-11	22	16 V
C734	1-161-140-11	0.047	ceramic (boundary layer)
C736	1-121-651-11	10	16 V
CT344, 444	1-141-010-XX	Trimmer	

RESISTORS

All resistors are in ohms. Common ¼ W carbon resistors are omitted. Check schematic diagram for values. k = 1000

R130, 230	1-210-850-11	300	±2% ¼ W carbon
R158, 258	1-244-857-11	220	½ W carbon

R701	⚠ 1-217-371-11	0.47	¼ W fusible
R702	⚠ 1-217-375-11	1	¼ W fusible
R706	⚠ 1-217-465-11	0.47	1 W fusible
R707	⚠ 1-217-485-11	22	1 W fusible
R713	⚠ 1-244-873-11	1k	½ W carbon
R719	⚠ 1-244-865-11	470	½ W carbon
R720	⚠ 1-217-375-11	1	¼ W fusible
R721	⚠ 1-206-511-11	10	3 W metal-oxide (nonflammable)
R722	1-244-881-11	2.2k	½ W carbon
R755, 757	1-244-869-11	680	½ W carbon
R765	1-244-873-11	1k	½ W carbon

Ref. No.	Part No.	Description	
R773	⚠ 1-217-465-11	0.47	1 W fusible
R787	1-206-527-11	47	3 W metal-oxide (nonflammable)
R792	1-206-520-11	24	3 W metal-oxide (nonflammable)
RV101, 201	1-224-250-XX	2.2 k adjustable	
RV102, 202	1-224-251-XX	4.7 k adjustable	
RV103, 203	1-224-550-21	220 adjustable	
RV104, 204	1-224-821-00	20 k variable, LINE OUT LEVEL ADJUST	
RV105, 205	1-224-251-XX	4.7 k adjustable	
RV106, 206	1-224-333-00	10 k variable, FM CAL	
RV301, 401	1-224-561-00	20 k variable, REC LEVEL-MIC	
RV302, 402	1-224-736-00	50 k variable, REC LEVEL-LINE	
RV303, 403	1-224-823-00	20 k variable, REC MASTER- PRESET/VOLUME	
RV305, 405	1-224-644-XX	4.7 k adjustable	
RV306, 406	1-224-756-00	20 k variable, CAL	
RV307, 407	1-224-822-00	20 k variable, PHONES LEVEL	
RV501	1-224-646-XX	22 k adjustable	
RV601	1-224-493-00	10 k adjustable	
RV701, 702	1-224-251-XX	4.7 k adjustable	
RV703, 704	1-224-250-XX	2.2 k adjustable	
RV705	1-224-253-XX	22 k adjustable	

SWITCHES

S1	1-516-685-00	Lever Slide, MONITOR
S2	1-552-025-00	Rotary Slide, DOLBY NR
S3	1-516-365-00	Rotary Slide, MIC ATT
S4	1-516-685-00	Lever Slide, MPX FILTER
S5, 6	1-516-482-00	Lever Slide, EQ, BIAS
S7	⚠ 1-516-693-00	Pushbutton, POWER
S9, 10	1-516-974-00	Slide, TIMER, MEMORY
S11	—	Included in tape counter
S12	1-516-028-XX	Micro, erasure-proof
S19	1-516-383-00	Micro, cassette detecting

JACKS

CNJI, 2	⚠ 1-526-528-00	AC OUTLET
---------	----------------	-----------

Note: The components identified by shading and ⚠ mark are critical for safety. Replace only with part number specified.

<u>Ref. No.</u>	<u>Part No.</u>	<u>Description</u>
CNJ3	1-507-255-00	Connector, 11-p; REMOTE CONTROL
CNJ101, 201 CNJ301, 401	1-507-433-00	Phono, 4-p; LINE OUT, LINE IN
CNJ302, 402	1-507-455-00	MIC
CNJ501	1-507-507-00	HEADPHONES
CNJ502	1-507-453-00	LINE IN (STEREO)

SOLENOIDS

PM1	1-454-145-00	Tape Pull-out
PM2	1-454-144-00	Pinch Roller Drive
PM3	1-454-156-00	Eject
PM4	1-454-130-00	Brake

MISCELLANEOUS

CPI	△ 1-231-057-31	Encapsulated Component
-----	----------------	------------------------

<u>Ref. No.</u>	<u>Part No.</u>	<u>Description</u>
CP501	1-464-061-00	Unit, bias osc
EH501	8-825-676-00	Head, erase; EF172-65
M1	8-835-003-00	Motor, capstan; DNF-1400A
M2, 3	8-835-005-00	Motor, reel; MNR-1500R
ME101, 201	1-520-258-00	Meter, VU; including PL2, 3
PH501	8-825-674-00	Head, playback; PF169-6502
PL1	1-518-145-XX	Lamp, 5 V 60 mA
PL2, 3	1-518-273-00	Lamp, 6.3 V 70 mA; meter
PL4 ~ 13	1-518-115-XX	Lamp, 6 V 35 mA
RH501	8-825-673-00	Head, record; RF169-6502
RY1	1-515-267-00	Relay
TI	△ 1-442-740-00	Transformer, power
	1-536-401-XX	Terminal Strip
	△ 1-534-538-XX	Cord, power

ACCESSORIES & PACKING MATERIALS

<u>Part No.</u>	<u>Description</u>
X-3549-745-0	Cushion Ass'y, upper
X-3701-018-3	Tips Ass'y, head cleaning
1-534-049-31	Cord, connection; RK-74H
3-429-126-00	Bag, plastic; set
3-548-770-00	Spacer, cassette lid
3-548-788-00	Cushion, lower (front)
3-548-789-00	Cushion, lower (back)
3-548-797-00	Carton
3-701-985-00	Tape Driver
3-780-963-22	Manual, instruction
8-893-508-10	Tape, demonstration

Note: The components identified by shading and △ mark are critical for safety. Replace only with part number specified.